

# Mobile Video Recorder

## User's Manual Installation Manual

---

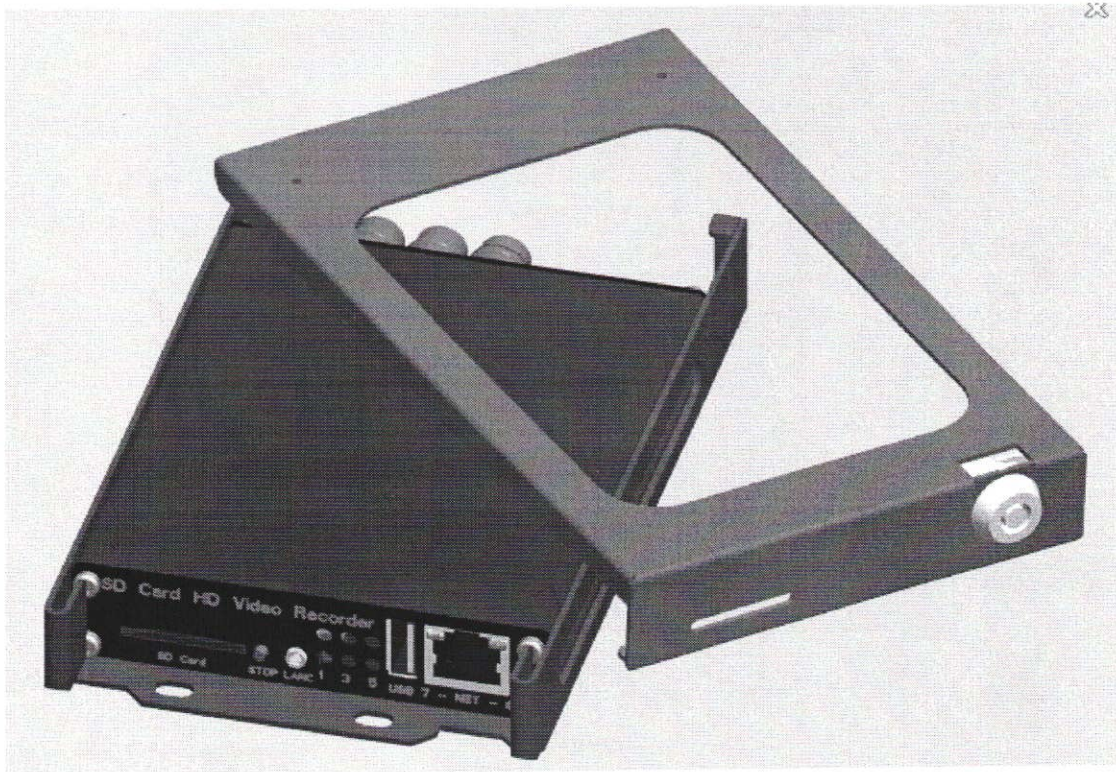

Thank you for using our SD Video Recorder. This manual is applicable for SD Video Recorder, Please read this User's Manual carefully to ensure that you can use the device correctly and safely. The contents of this manual are subject to be changed without notice.

## Warning

**This device is NOT of waterproof; to prevent it from any accident of fire or electric shock, please do NOT put any container with water on the device or nearby. Do not expose the device to moisture, or extreme temperatures.**



This lightning flash with arrow symbol within an equilateral triangle is intended to alert users that there might be uninsulated dangerous voltage which may cause electric shock to person when the cover of device is opened.

### CAUTION

RISK OF ELECTRIC SHOCK

DO NOT OPEN

To prevent from the risk of electric shock, do NOT remove top cover or back cover. There is NO user-serviceable part inside. Ask for service from qualified maintenance man.



The exclamation point within an equilateral triangle is intended to alert users the important operating and maintenance(servicing) instructions in this manual.



Important notice:

1. Please read over all cautions.
2. Please keep this manual for reference in the future.
3. Please notice all warning information.
4. Please strictly follow the instructions in this manual while operating.
5. Please NEVER put this device under the place which is easily poured by water.
6. Please do NOT use abrasive chemicals, cleaning solvents or strong detergents to clean the device. Wipe the device with a soft and dry cloth.
7. Please do NOT get the gate of airiness heat exchange closed.
8. Please leave the device far away from hot and high temperature environment.
9. Install the device with the accessories coming with it.
10. Please take care when moving the device, make sure of security, and avoid being damaged by dropping from high place.
11. Call for qualified maintenance man to repair when needed.
12. The device can only be installed horizontally. Installed vertically or out of the horizontal could hurt person or damage the device or/and its parts.

# **TABLE OF CONTENTS**

1. General Introduction .....	4
2. Product Description .....	6
2.2 Rear Panel .....	7
3. Start to use mobile DVR .....	8
3.1 Install and fix the cradle .....	8
3.2 Insert a SD card .....	8
3.3 Install the top cover of the cradle .....	8
3.4 Connect with cameras .....	9
3.5 Connect with power .....	10
3.6 GPS connection (Optional) .....	10
3.7 Connect with control panel (control panel is optional) .....	11
3.8 Connect with monitor .....	12
3.9 Format the disk .....	15
3.10 Setting up the cameras .....	15
3.11 Record Setting .....	17
3.12 Power Setting .....	18
3.13 Motor Setting .....	20
3.14 GPS Setting .....	21
3.15 G-Sensor .....	21
3.16 3G/4G Setting .....	22
3.17 WIFI Setting .....	23
3.18 Network Setting .....	23
3.19 Server Setting .....	24
3.20 System Setting .....	25
3.21 Alarm Setting .....	26
3.22 Set Date and Time .....	27
3.23 Output Setting .....	27
3.24 Record Play back .....	28
3.25 System Information .....	29
3.26 System Upgrade and Log .....	29
4. Specification .....	31
5. Trouble Shooting .....	33
6. Packing List .....	36

## 1. General Introduction

The Mobile SD video recorder is a compact, full-featured recording system that uses a SD card as a storage device. The recorder unit and associated accessories are specifically designed for operation in a mobile environment.

The Mobile SD video record system, used in conjunction with the cameras, records up to four channels of full-motion video and audio data to a removable SD card. The firmware-driven menu system provides a simple method for configuring the unit's operation as well as searching for and viewing previously recorded AV records.

### **Regulatory Compliance**

The Mobile Video Recorder complies with CE and Part 15 of the FCC interference limits for Class B digital devices FOR HOME OR OFFICE USE. These limits are designed to provide reasonable protection against harmful interference. Operation of this device is subject to the following conditions: (1) This device may not cause harmful interference, and (2) this device must accept any interference received, including interference that may cause undesired operation.

### **Product Description**

#### **Product Main Features**

- Embedded operating system, assuring reliability and system integrity.
- Records up to eight channels of full-motion color video with corresponding audio tracks.
- H.264 and H.265 High Profile video compression.
- Total Record resource up to 30 frame/second for each channel.
- Lockable security enclosure.
- Front panel USB2.0 port for recording to a flash card as an optional storage device.
- Ignition sense that provides DVR power-on in recording mode when the bus is started.
- Power-off delay record when the bus is shut-down with operator-selected delay times.

#### **Video And Audio**

- H.264 and H.265 High Profile video compression, real time recording 30 fps for each channel. Frame rate adjustable for each channel.
- Audio compression: PCM codec. This codec offers high compression with high quality audio.
- 4 channels for analogue camera.
- Local video and audio real time playback.

#### **GPS Time Synchronization & Time Zone**

- Synchronize the DVR system time with GPS automatically
- Support All Time Zones Worldwide
- Support DST (Daylight Saving Time)

#### **Power Management**

- Reliable power management, wide voltage: +8VDC~+32VDC; The power input is protected against short positive transient (1500 watts peak pulse power capability with a 10x1000 us waveform); The power input is protected against negative voltage. Applicable for vehicles with +12V or +24V battery.

- The recorder provides each camera with stable +12V DC power; DVR can detect the short cut on power circuit.
- Can use ignition to control the power.
- DVR can monitor battery voltage after Ignition off, and auto into sleep mode when voltage is bellow specified level.

### **Recording mode**

- Continuous record.
- Support schedule recording.
- Support alarm recording.
- Support motion detection recording.

### **Speed and Vehicle status recording**

- Record vehicle speed and car id with audio and video.
- Support 3 sensors, can be connected to return, right turn, left turn light etc.
- Over-speed alarm.
- Specified screen can be full screen displayed when return(or left, right) sensor trigged.

## 2. Product Description

### 2.1 Front Panel

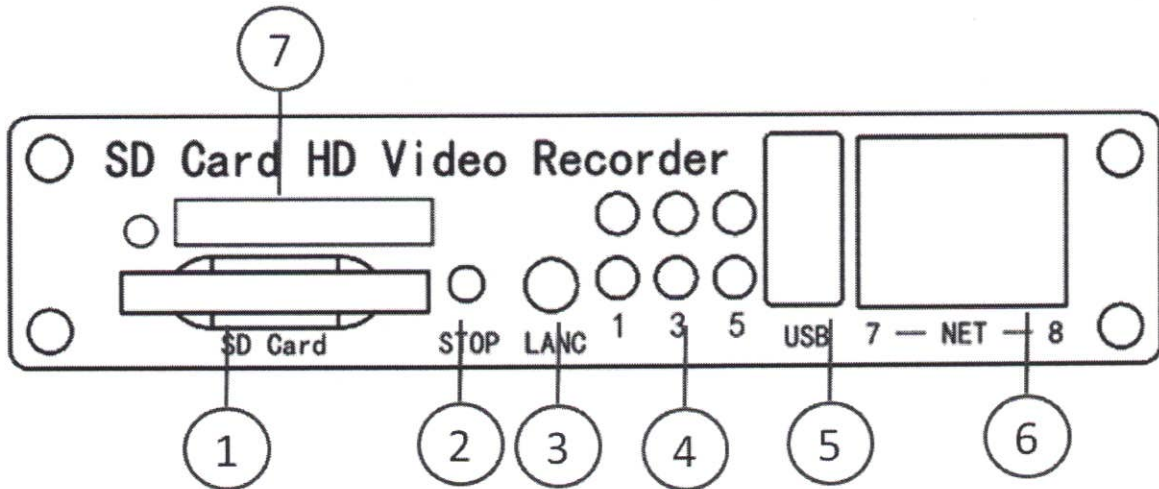

- 1: SD Card Slot
- 2: Stop Button
- 3: Control Panel Connector
- 4: Light Indicator (1:SYS 2:4G; 3:SD 4:ALARM; 5:PWR; 6:RUN)
- 5: USB Connector (Can connect with mouse)
- 6: Network Connector(RJ45)
- 7: SIM card slot

#### Get to know the status of DVR system by the indication of LED lights:

5. PWR	6. RUN	Description
Always on	Blinking	DVR is on & running
Blinking with RUN by turns	Blinking with PWR by turns	Ignition is not enabled and DVR is OFF.
Blinking together with RUN	Blinking together with PWR	Ignition signal is not enabled & DVR is running. Unit will turn OFF when "Delay Time" setting is reached.
Blinking every 3 seconds	Off	DVR is off. The lock is in off state and user can use key to turn on the DVR

1. SYSTEM	Description
Always On	8 cameras recording together
Blinking	Blinking every 2 seconds. The number of blinks is the number of camera not connected. For example, if it blinks 3 times, it means there are 3 cameras not connected.

Off	Not recording and no cameras connected.
-----	---

2. 4G	Description
On	Depends on the 4G module
Off	Depends on the 4G module

3. SD	Description
Always On	Disk in use, Recording or Playing.
Off	Disk not in use

4. Alarm	Description
Always On	DVR has alarm report(Over speed, e.g.)
Off	No alarm

## 2.2 Rear Panel

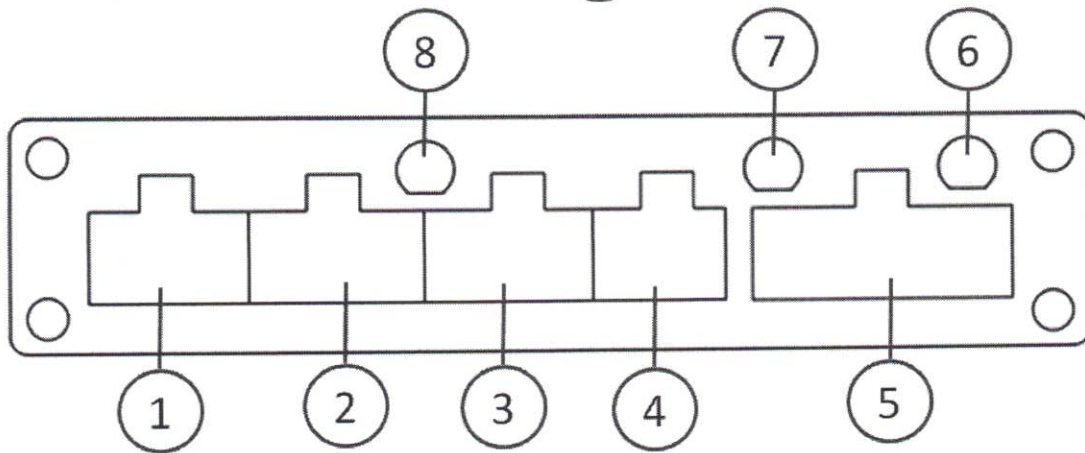

- ①: Power (including Power, Ground, Ignition).
- ②: Camera 1 and 2(including power for camera)
- ③: Camera 3 and 4(including power for camera)
- ④: CVBS Video and Audio Out (including power for monitor)
- ⑤: 3 sensors, 1 RS232 (For GPS), 5V DC output, 1 LANC input
- ⑥/⑦: WIFI antenna
- ⑧: 4G/3G antenna

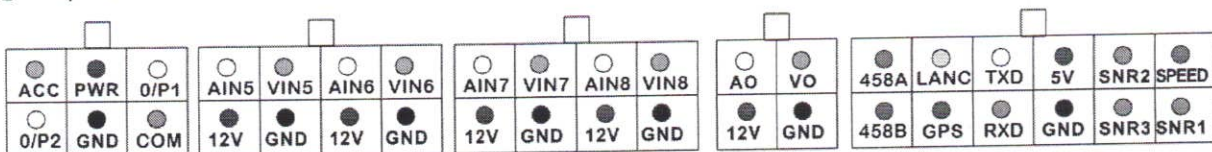

### 3. Start to use mobile DVR

#### 3.1 Install and fix the cradle

Use a power drill and screws supplied to fix cradle in the right place inside the vehicle.

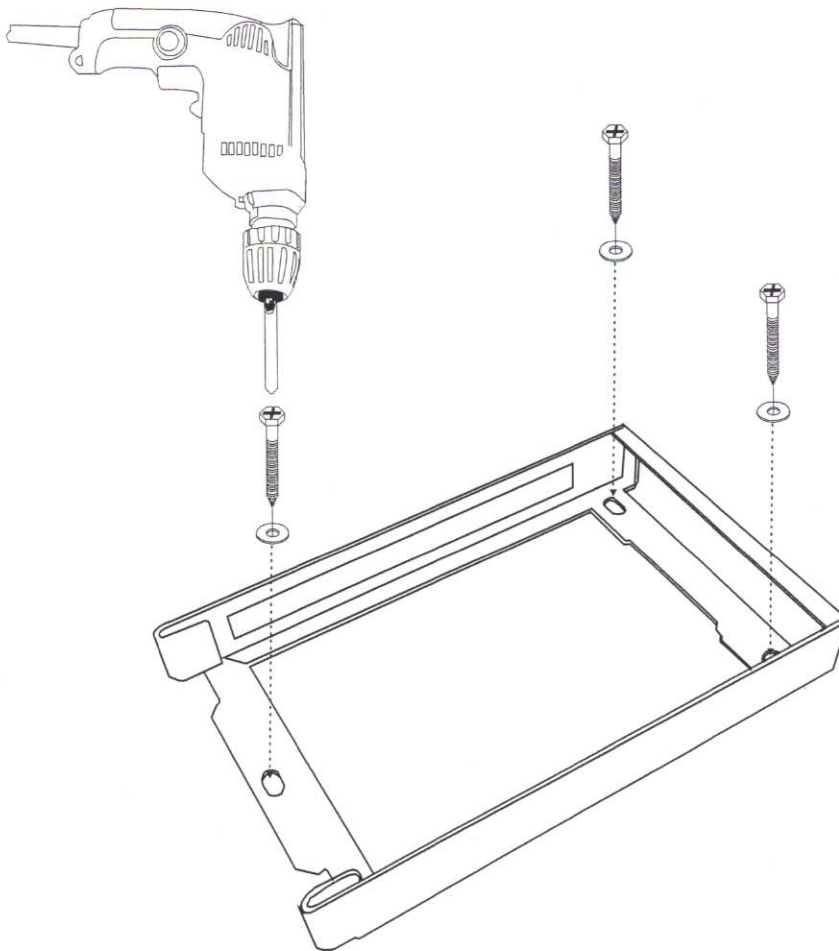

#### 3.2 Insert a SD card

Put a SD card in to the card slot.

#### 3.3 Install the top cover of the cradle

Put the top cover into the cradle and use the lock to secure it.



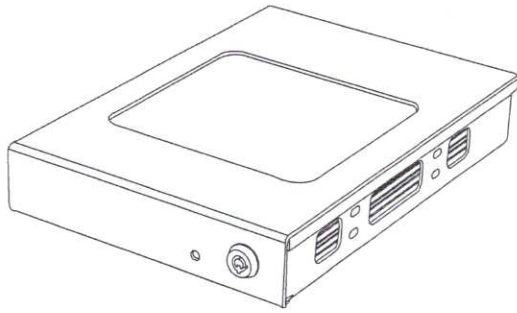

### 3.4 Connect with cameras

The SD DVR can connect analog cameras. The analog cameras can be connected using the BNC connectors or 4-pin threaded connected in the cable we provided.

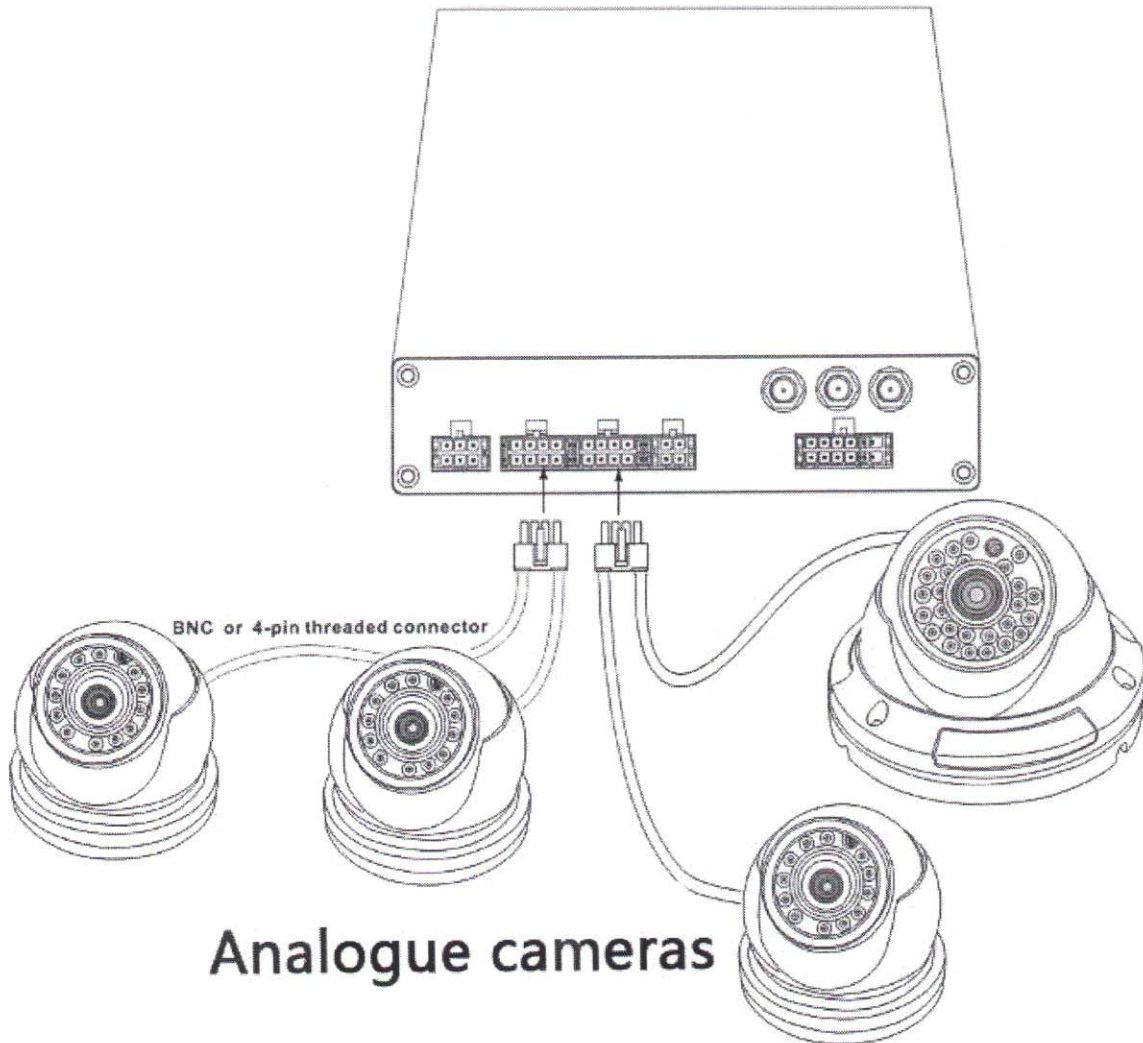

### Analogue cameras

If you are using the 4-pin threaded connector, the camera should have 4-pin female connector to match this cable. The DVR unit will provide stable 12V DC power to each camera, and record video and audio (if the camera is with microphone built-in). This type of connection cable is highly recommended. It saves both installation time and cost.

### 3.5 Connect with power

Connect the red wire to the positive pole of the battery and connect the black wire to the negative pole of the battery. Connect the yellow wire to the ignition signal of the vehicle. The fuse should be connected to the positive pole and red wire. Please note: the fuse is used for protecting the battery, so the fuse should be placed near to the battery positive pole.

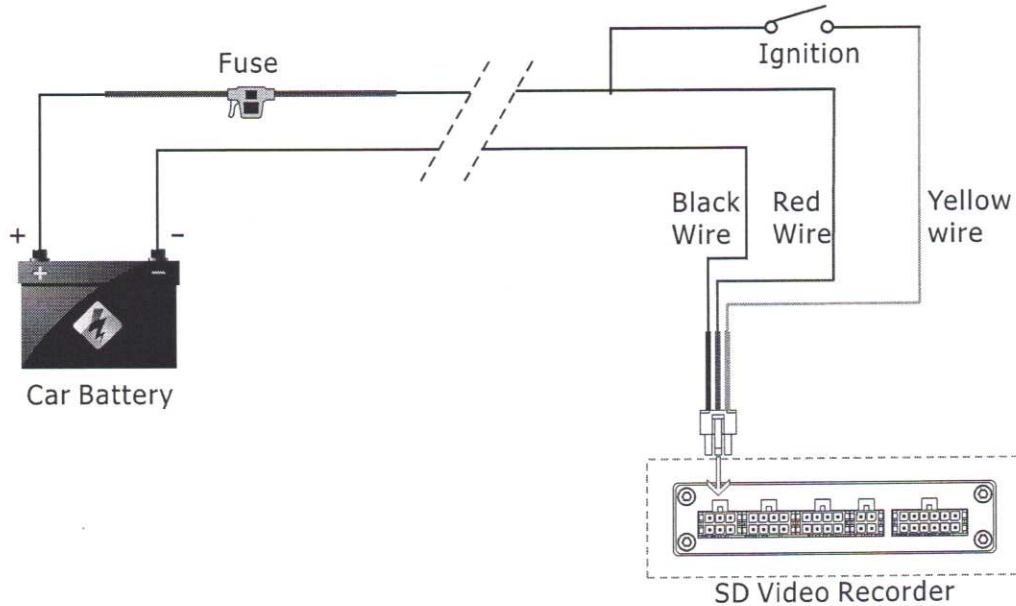

#### NOTE

1. The DVR uses DC power input, please be very careful when connecting to the "+" and "-" of the power supply.
2. Wide voltage range of 8V-32V for the DVR. The DVR may be damaged if the voltage comes too high. And the DVR may not work if the voltage comes too low.
3. Power of the DVR should be supplied by the car battery.
4. Power consumption of the DVR can be 60W when the engine starts. All the cables for connecting from power to the DVR should be thick enough for current over 5 Amperes.
5. To protect the battery from being damaged of short circuit, the fuse should be placed very closed to the "+" pole of car battery.

### 3.6 GPS connection (Optional)

Connect the GPS receiver to the GPS connector on the cable harness.

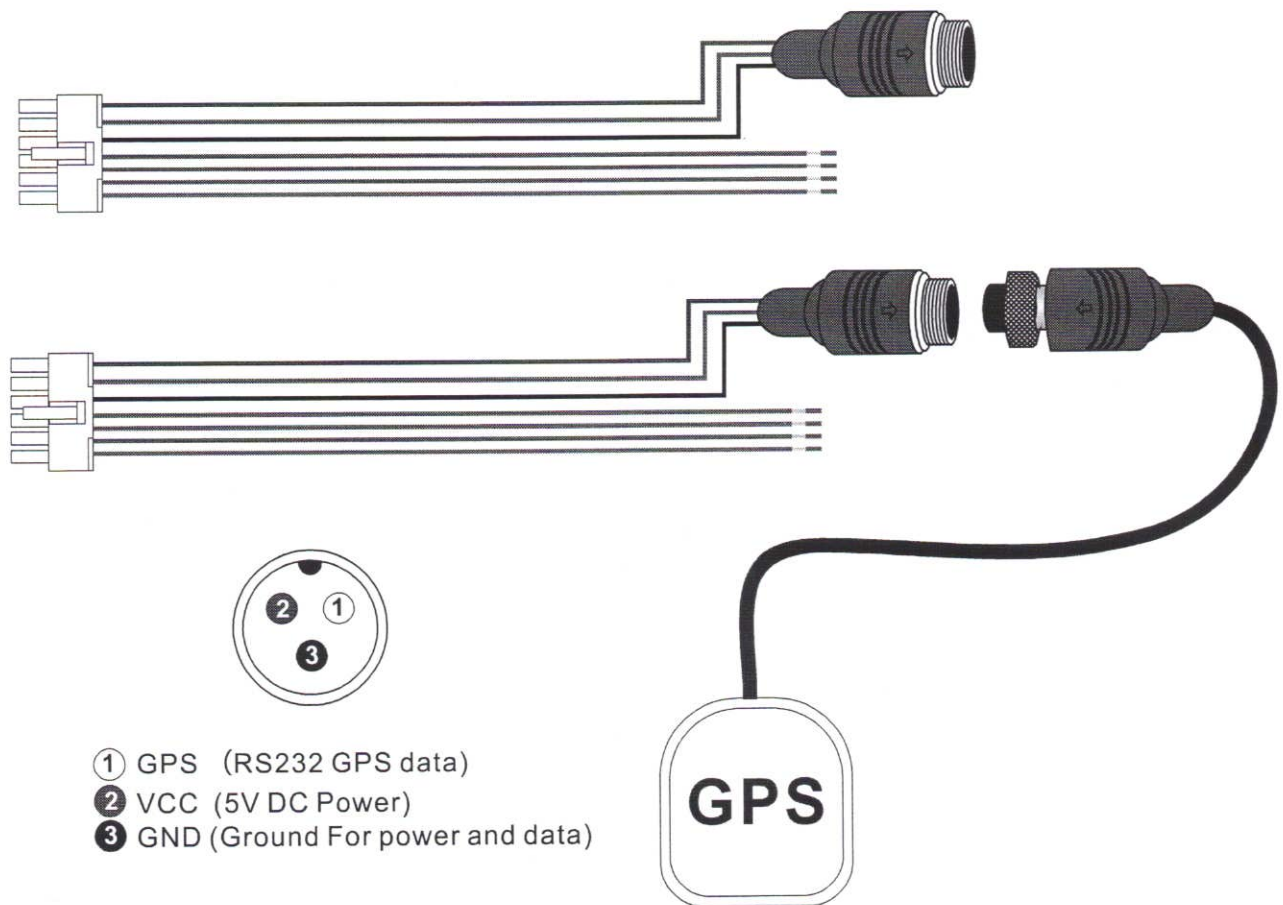

### 3.7 Connect with control panel (control panel is optional)

The control panel can be used as panic button, or used for toggle screen display among different cameras. The control can also show the status of the DVR, including error status. When the DVR is installed in a place which is hard to reach, the control panel can be installed in a place which is easy for use to check the DVR.

The control panel have one button and three LED light (yellow, red and green light).

The button can work as either one of the following three functions:

Panic button: The button can be used as panic button. When this button is pressed, the recording will be marked as alarm recording and this record file will not be overwritten. If the DVR support 4G function, it can send alarm message to control center.

Start/Stop record: The button can be used as Start/Stop record button. The record status can be seen on the LED light indicator.

Toggle cameras: The button can be used for toggling among cameras.

The status indicator will show the status of the DVR, as following table:

TYPE	STATUS	DESCRIPTION
RECORD	Green Light Always On	Recording
	Green Light Blinking	No recording

POWER	Yellow Light Always On	DVR is on
ERROR	Red Light Blinking Fast	Panic button is pressed
	Red Light Blinking Slowly	No disk found

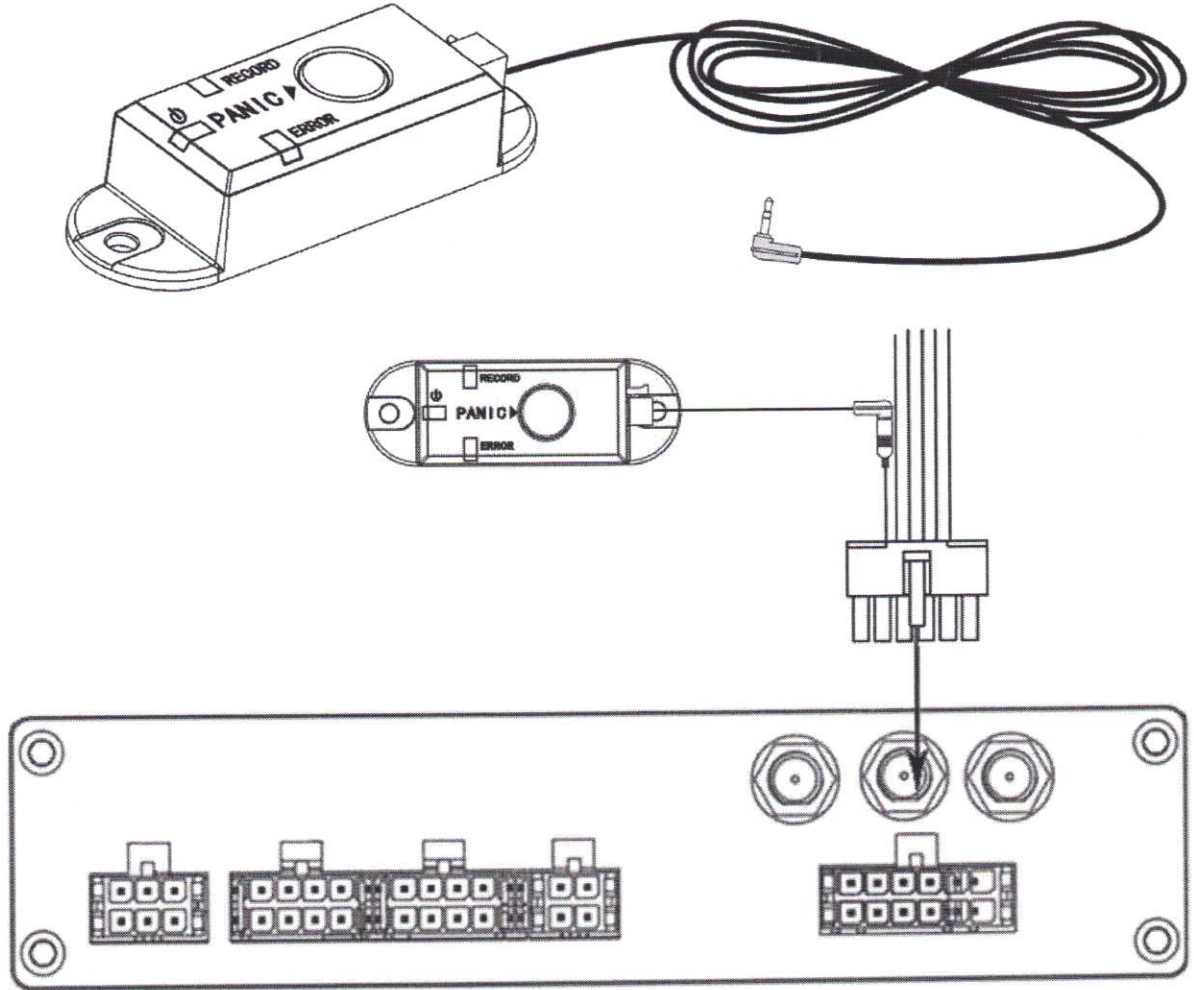

### 3.8 Connect with monitor

3.8.1 Connect the DVR with monitor  
 DVR can be connected with CVBS monitor.

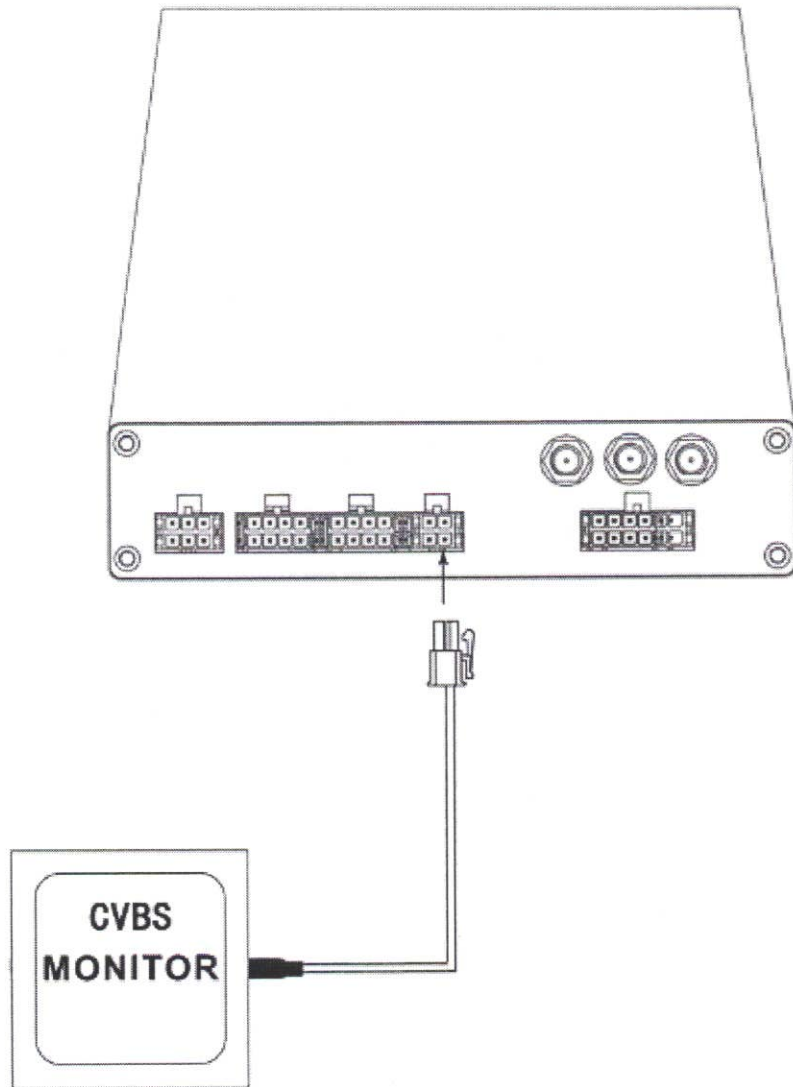

Connect with CVBS monitor (composite video)

Use the composite video cable to connect the monitor with DVR. When the DVR is turned on, it will show the DVR output.

### 3.8.2 Preview Cameras

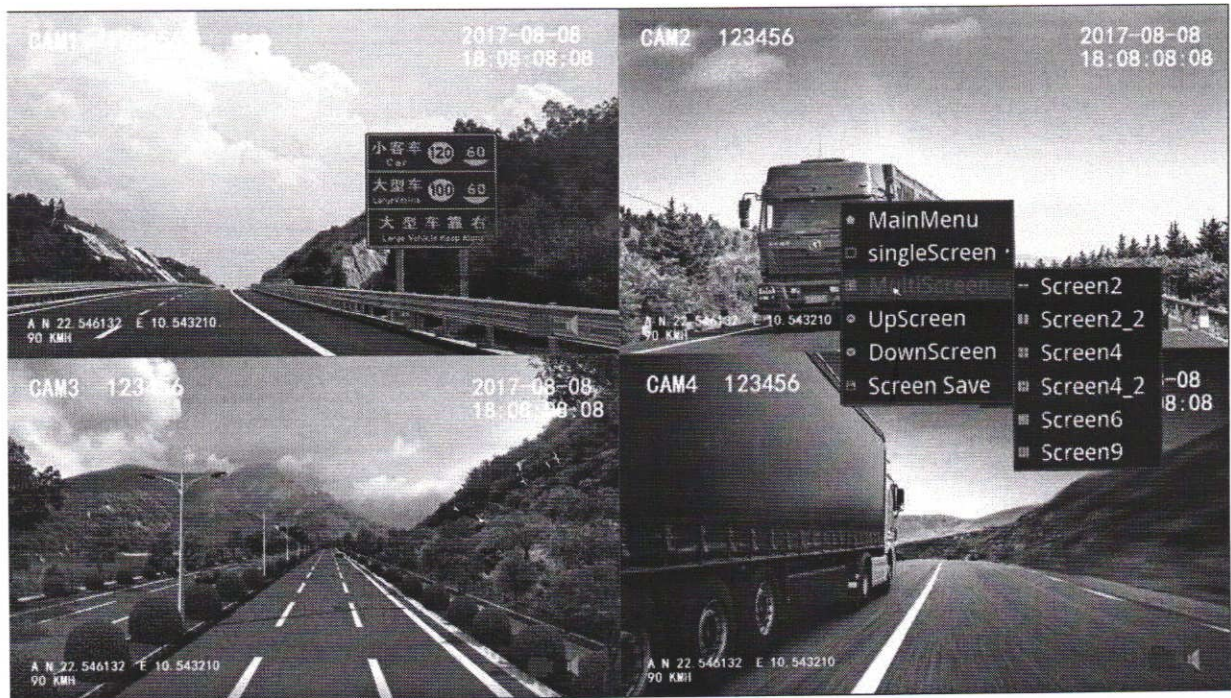

1) Use mouse to toggle among cameras

When the DVR is turned on, the DVR will display preview screen automatically. User can connect a mouse to the USB in the front panel, then right click the mouse. Choose the screen mode in the prompted menu. You can also choose one camera as full screen mode by double clicking the camera.

2) Use the control panel to toggle the screen or channel

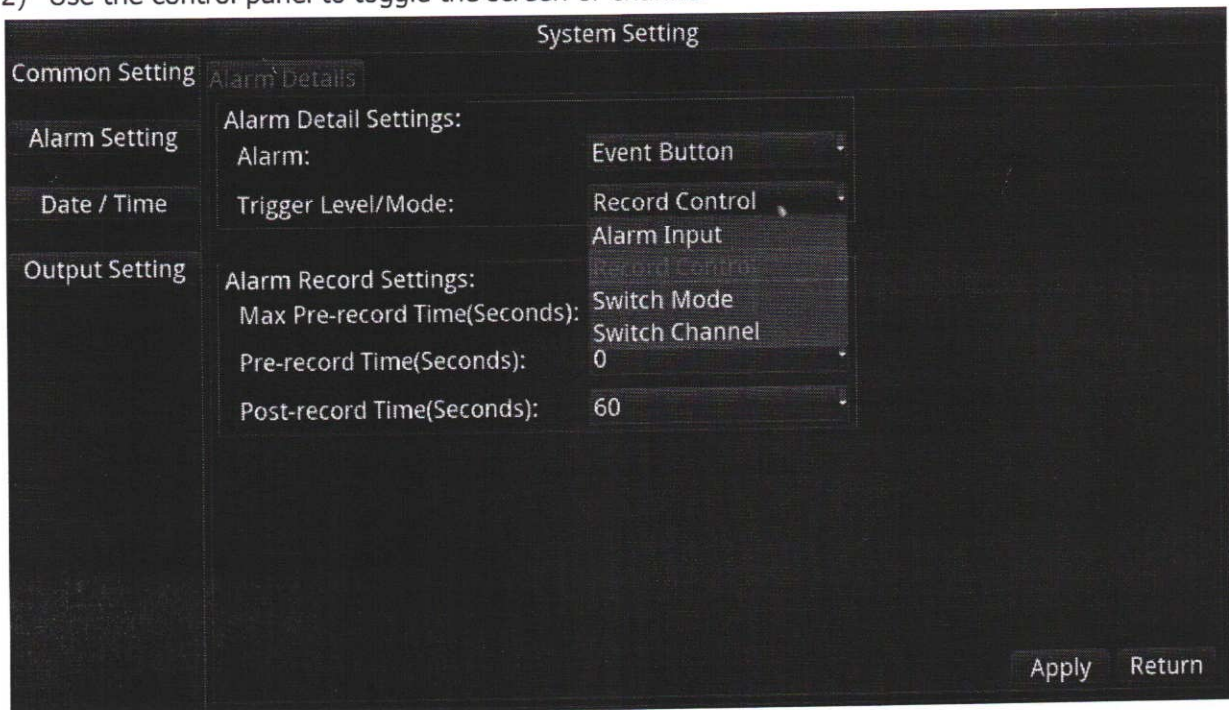



Connect the control panel with DVR, right click to select "main menu", then can choose the "Switch mode" or "Switch Channel" in the alarm setting menu. After the "Switch mode" or "Switch Channel" is set, you can toggle the camera by pressing the button on the control panel.

### 3.8.3 Audio output

DVR support HDMI or SD display audio real-time output, user can click on the small audio icon



to open or close the video output, the icon  means that real-time audio output is ON, the icon  for the real-time audio output is OFF. Audio output device is set by "Output Device" setting.

### 3.9 Format the disk

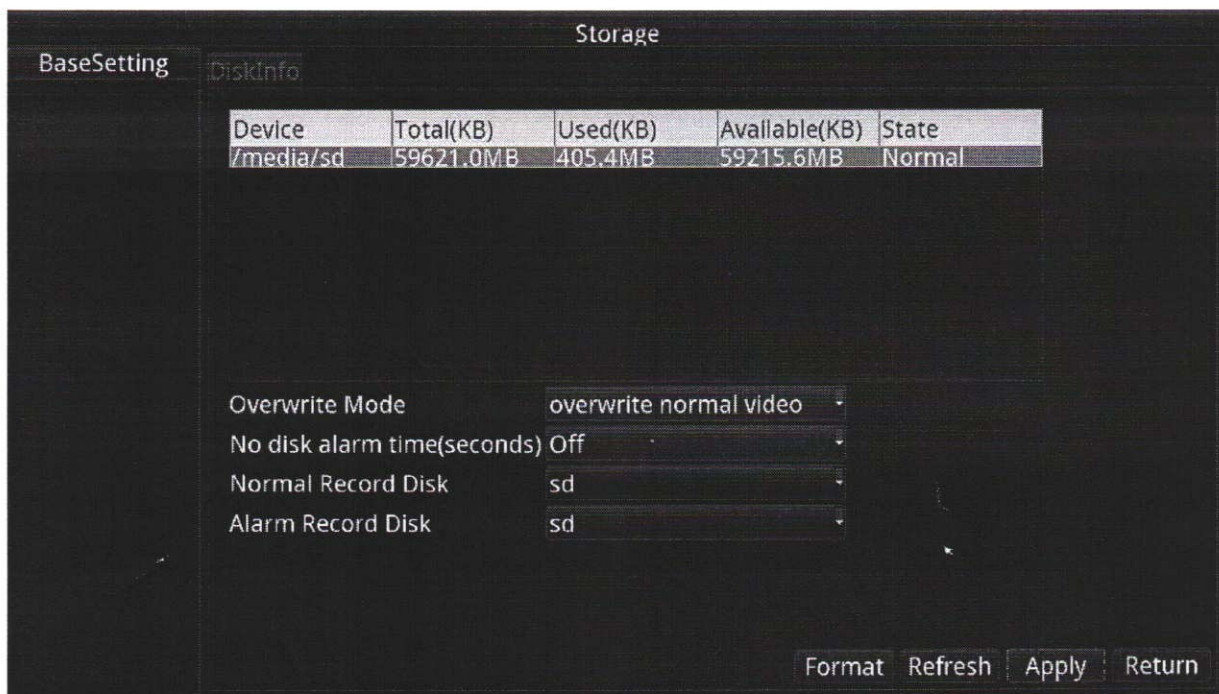

1. When the disk is used in the DVR for the first time, it should be formatted first.
2. Right click the mouse and choose "main menu", then choose "storage". Choose the disk you need to format and click "format" button to format the disk.
3. If no disk is found, the DVR will show "no disk" error message. If there is some error on the disk, such as write error, the error message will also be displayed.
4. When the disk is full, the DVR can be configured to overwrite the earliest file.

**Note: The format operation will lose all of the data on the disk. Please backup all of the data on the disk before formatting the disk.**

### 3.10 Setting up the cameras

In the "preview" setting, you can set the cameras parameters and motion detection.

#### 3.10.1 Camera Setting

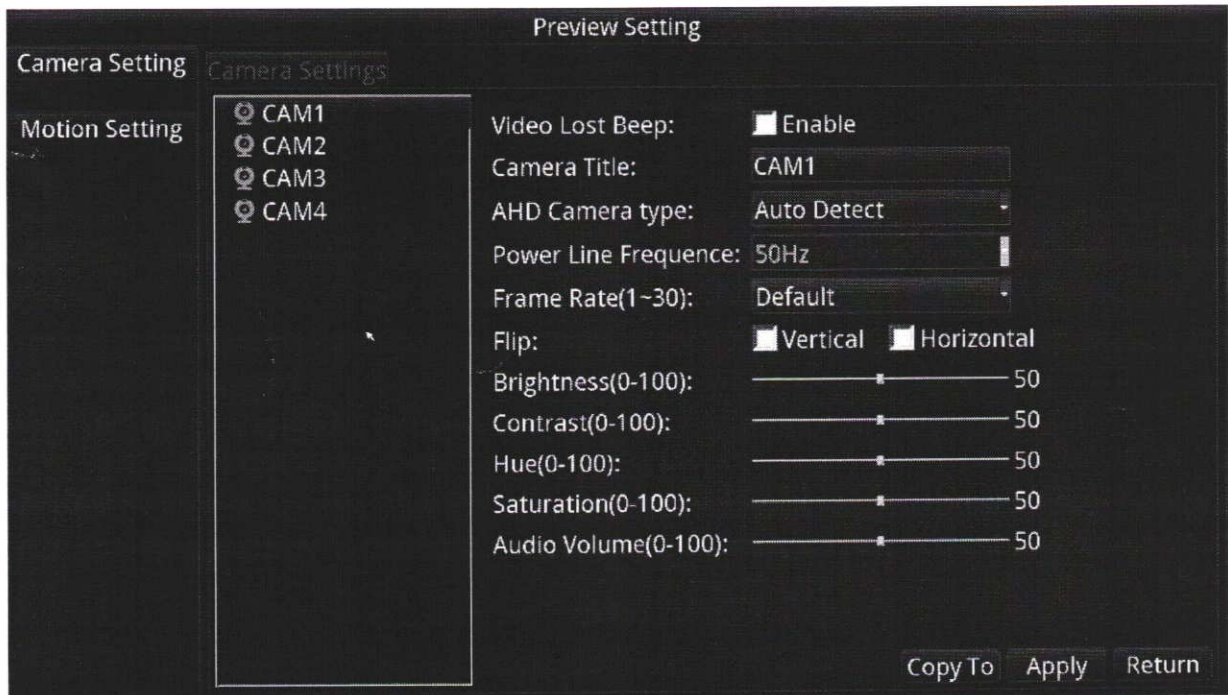

- When the camera is lost, DVR can be configured to beep.
- You can choose to set the parameters of "CAMx", including Camera Title, Frequency, Flip Mode, Brightness, Contrast, Hue, Saturation, Audio Volume, etc.
- The Camera Title should be less than 16 characters.
- The flip mode can be Vertical or Horizontal..

### 3.10.2 Motion Detection

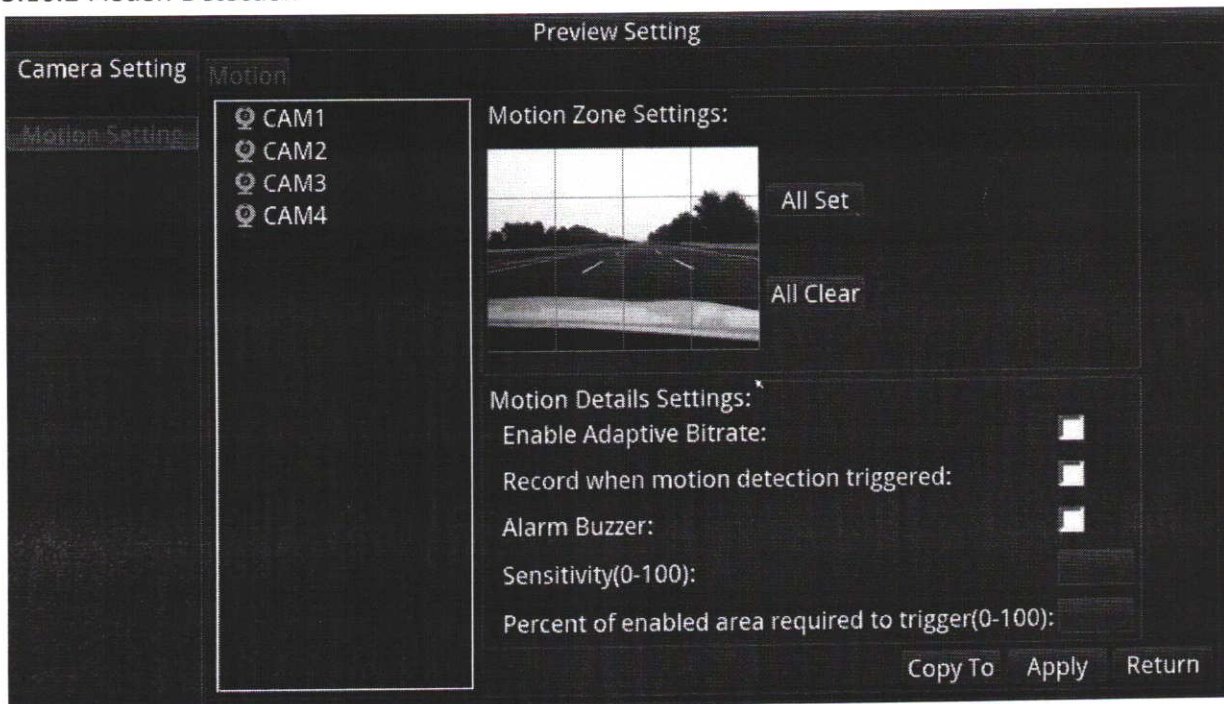

- User can set motion detection area.
- DVR can be set to use Adaptive Bitrate to get better video quality, can be set to start recording when motion detected, can be set to trigger beeper when motion detected.
- User can set the sensitivity of the motion detection. The higher the value is, the more sensitive



the DVR will be.

## 3.11 Record Setting

### 3.11.1 Setting Record Details

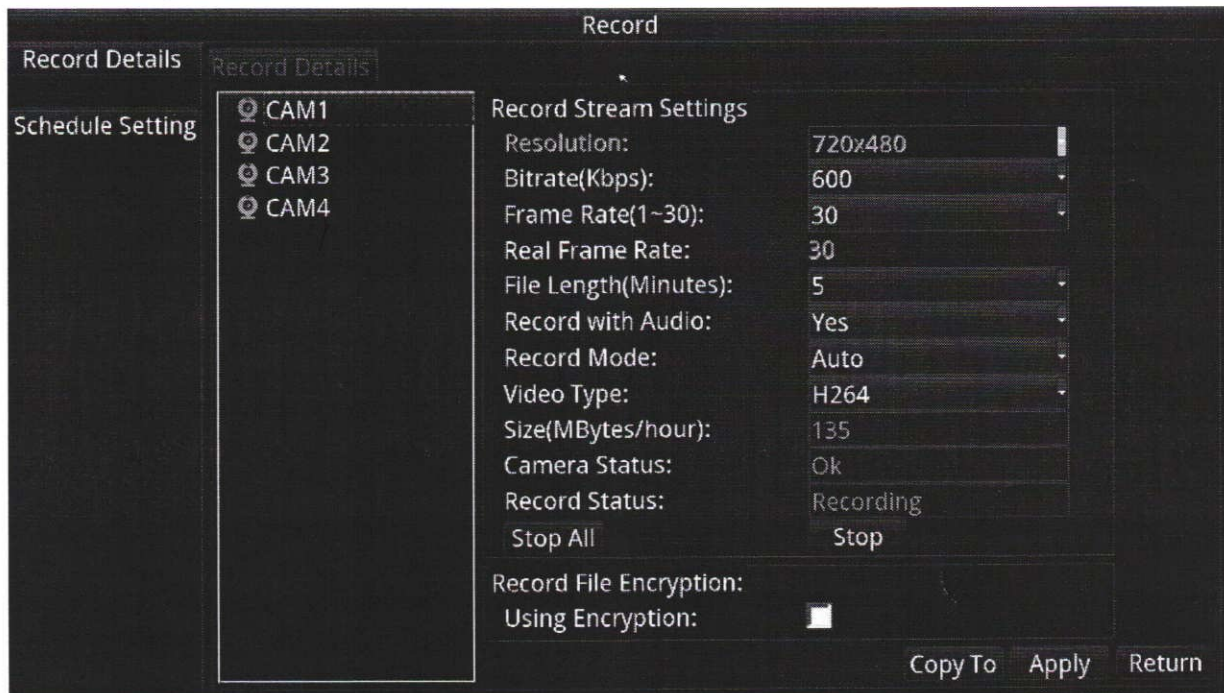

- Each camera can support 480P/30fps recording(depends on the camera), the bitrate range from 100Kbps to 8000Kbps. The recording support adaptive bitrate control to save recording space. The bitrate can be down to only 50% of the setting value if there are no too much motion in the video. For example, if the setting is 480p/25p, 1200Kbps, the actual bitrate can be down to 600Kbps if there are few motion in the video.
- If you are using high bitrate for recording on the SD card, please choose fast speed SD card, Class 10 SD card for example.
- The file length can be from one minute to four hours. Due to the limit on FAT32 file system, each file size cannot be over 2GB. When the file length is too long and bitrate is too high, the file size could be over 2GB. In this case, the DVR will close the file and create a new file automatically to avoid this error.
- There are H264 and H265 video modes can be set. Theoretically, H265 consumes 50% less storage space than H264 under the same picture quality.
- The file size for one hour recording displayed in the menu is for your reference. The actual file size could be little different.
- The record mode support manual/auto/off mode. The default mode is auto. In this mode, the DVR will start record on this camera automatically when the DVR is turned on. If it is set to manual mode, the DVR will not record on this camera until user do it manually. User can use mouse to start record on this camera manually. If this mode is set to off, the DVR will not record on this camera.
- You can click the "start" or "stop" button to start/stop recording on this camera.
- You can click the "apply" button to save the setting.

- The record can be encrypted if you check "using encryption". If the file is encrypted, the record file can't be played by using other player software. You can only use the player software provided by us and need to input the password to play this file.

### 3.11.2 Record Schedule

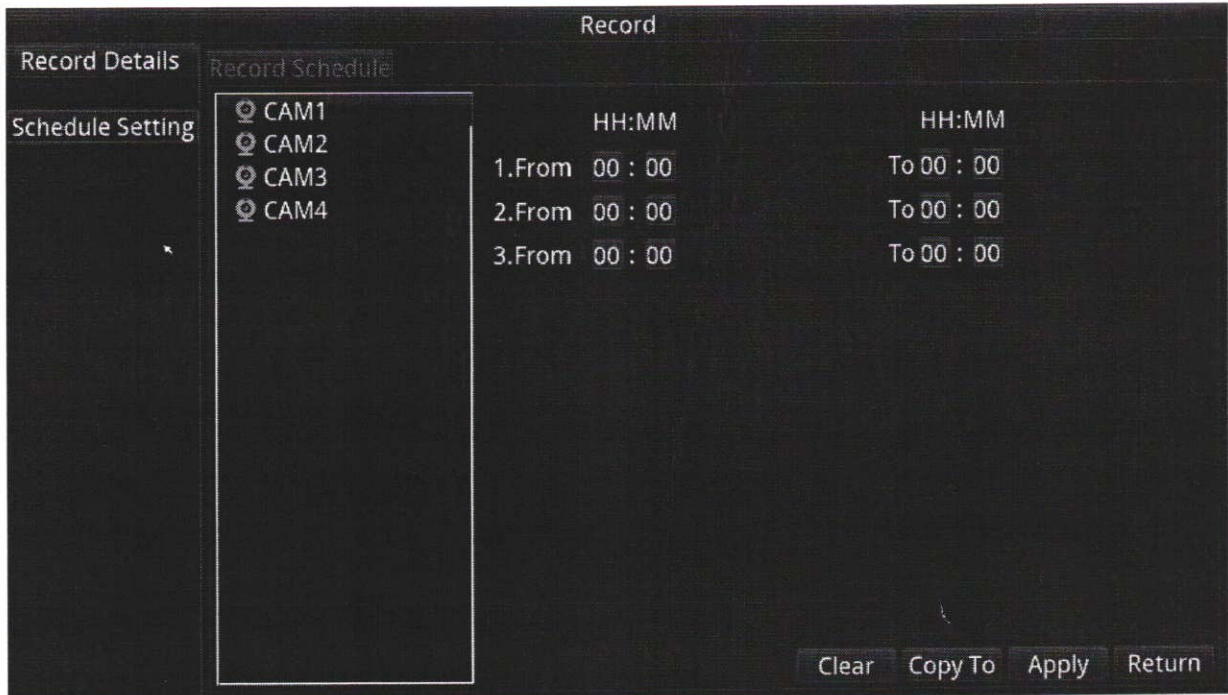

- The record schedule support three different rules for recording.
- All cameras can use the same rule. Each camera can use special rule.

### 3.12 Power Setting

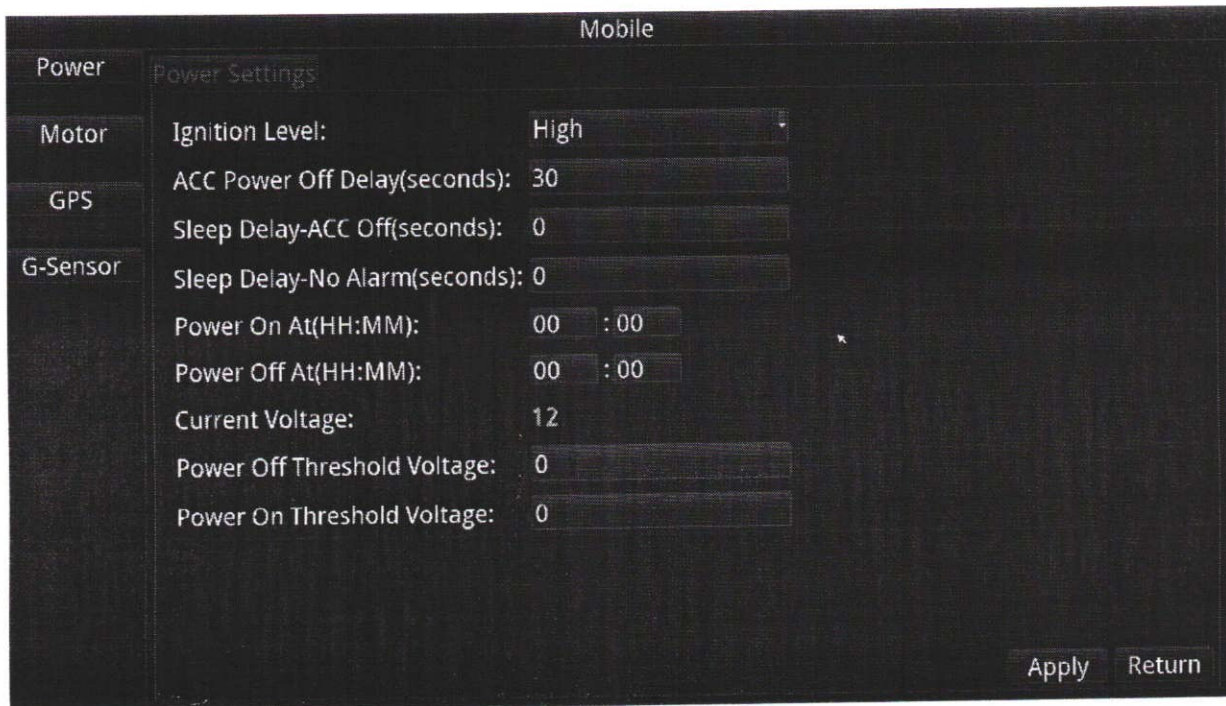

- Ignition Level: "Ignition Level" is the voltage level when the ignition is turned on. By default, it is "High". In some special vehicle, this value should be set to "Low".
- ACC Power Off Delay: The DVR can be set to keep on for some time and then turned off automatically after the ignition is turned off. This value is in seconds, the default value is 30 seconds. In this case, the DVR will be going to standby mode and the DVR will be not working. In standby mode, the DVR will not be powered on again unless the ignition is turned on again. And even if the ignition is turned on again, the DVR will still need about one minutes to boot up completely to start recording. If the "ACC Power Off Delay" is set to 0, the DVR will be always on and will not be turned off even if the ignition is turned off.
- Sleep Delay-ACC Off: This parameter is used to set the timeout when DVR is going to sleep mode after the ignition is off. In sleep mode, the camera will be turned off, but the DVR will be still working. This is different than the case when using the "ACC Power Off Delay" to let DVR go into standby mode. In sleep mode, as the DVR is always working, the DVR can power up the camera and start recording immediately if there is any alarm. The DVR don't need to take time (about one minute) to boot up before recording. The "Sleep delay-ACC Off" value usually should be set to a value larger than "ACC Power Off Delay", otherwise the DVR will go into standby mode before going into sleep mode. If "Sleep Delay-ACC Off" is set to zero, the DVR will not go into sleep mode.
- Sleep Delay-No Alarm: This parameter is use to set the timeout when DVR is going to sleep mode after last alarm (event) occurred. If this value is set to zero, the DVR will not going to sleep mode even if there is no alarm for long time.
- Timer Power On/Off: This is used to set the DVR to turn on/off at specified time. If both value is set to "00:00", this feature is disabled.
- Power On/Off Threshold Voltage: When the voltage connected to the DVR is bigger/smaller than the Power On/Off Threshold Voltage, the DVR will turn ON/OFF. When it is set to "0", the setting is OFF.

The reason that we have two power save mode (the standby mode and the sleep mode) for DVR is that in some case the DVR should resume recording immediately from power save mode. In standby mode, the DVR is turned off and the cameras are also turned off, the power consumption will be very small. But the DVR need about one minute to boot up before it can resume recording. In sleep mode, the DVR is still on but the cameras will be turned off. The sleep mode will have more power consumption than standby mode but will have less power consumption than working mode. A typical use for sleep mode and standby mode is for taxi application. The DVR can set "ACC Power Off Delay" to 21600 seconds (6 hours), set "Sleep Delay-ACC off" to 10800 seconds(3 hours), set "Sleep Delay-No Alarm" to 10800 seconds(3 hours). We will also connect the taxi meter signal to the "Sensor 1" (Alarm 1) and the door open signal to "Sensor 2" (Alarm 2) and these two sensors will trigger recording. With this configuration, if the taxi is parking (no ignition) for 3 hours and there is no passenger (no meter on or no door open) for 6 hours, the DVR will be in sleep mode. But during this time, if the taxi is turned on or there is any passenger, the DVR will start recording immediately. If the taxi is parking (no ignition) for 6 hours and there is no passenger (no meter on or no door open) for 6 hours, we will think the taxi is not running, the DVR will be in standby mode.

### 3.13 Motor Setting

Category	Field	Value
Motor	License ID:	2222222
GPS	Obtain Speed :	From GPS(If Any)
GPS	Speed Unit:	KMH
G-Sensor	Speed Limit(KMH/MPH):	80
G-Sensor	Overspeed Record:	Set
G-Sensor	Overspeed OSD:	
G-Sensor	Overspeed Buzzer:	Off

- License ID: Set the plate number, support characters (case sensitive) and numbers.
- Support to get speed from speed, the speed unit can be km/h or mile/h;
- Can set the overspeed value. The over speed alarm can be used to trigger recording. If the over speed value is set to zero, the over speed alarm will be disabled.
- "Overspeed OSD" is used to set the tile displayed when over speed.
- "Overspeed Buzzer" is used to turn on/off buzzer when over speed.

## 3.14 GPS Setting

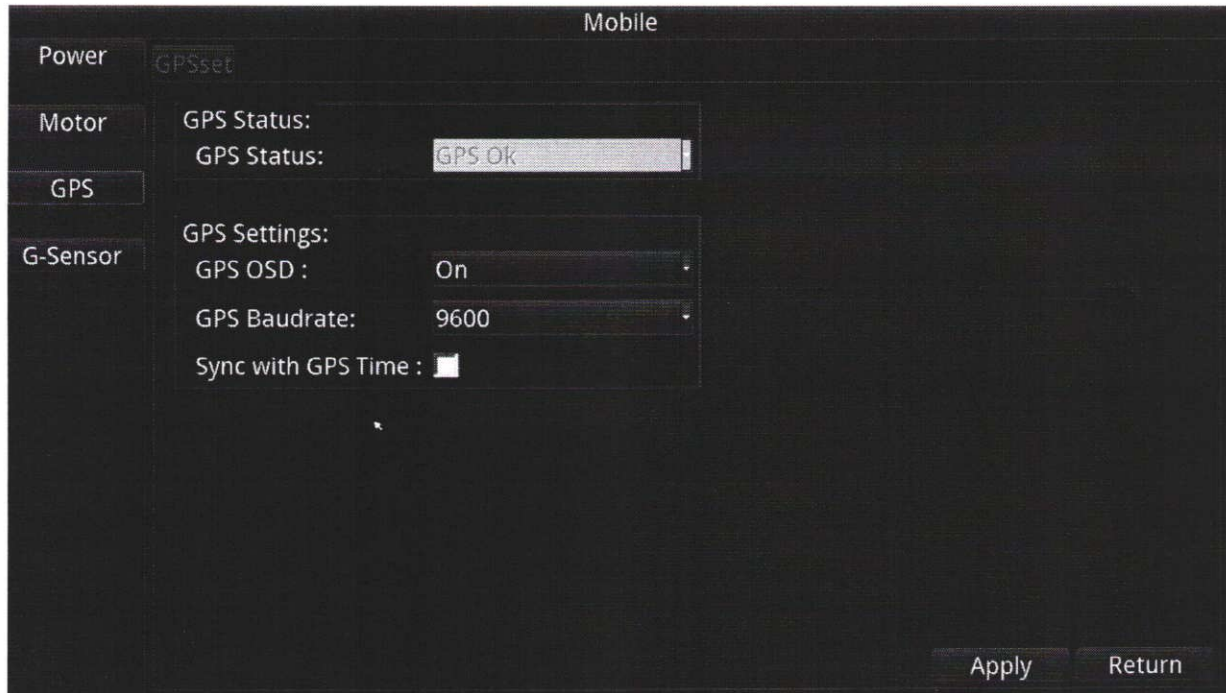

- GPS Status:  
GPS Not Found: No GPS found on the DVR.  
GPS Gprms: DVR got "GPRMC" data from GPS, but GPS signal is not good.  
GPS OK: GPS working correctly.
- GPS OSD: If this option is turned on, the GPS data (latitude and longitude) will be displayed and record with video.
- GPS OSD: If this option is turned on, the GPS data (latitude and longitude) will be displayed and record with video.
- Sync with GPS Time: When this option is turned on, the DVR will synchronize with GPS time.
- GPS Baud rate: The communication bard rate between GPS and DVR. The default value is 9600.

## 3.15 G-Sensor

- Instant Value: It shows the current value from G-Sensor in axis X, Y and Z. Due to the gravity, if the DVR is put horizontally, the initial value of axis Z will have about 1.0G and the value will be about -1024.
- Initial Offset: The "Initial Offset" is used to have a base value for alarm threshold. As DVR will be installed in different place, the "Initial Offset" can be set to the initial value displayed in "Instant Value". In this way, if there is any change between current G-Sensor data and the initial Offset, we will think there might be something happened.
- Alarm Threshold: The "Alarm Threshold" is used to set the threshold to trigger alarm. If the difference between "Instant Value" and "Initial Offset" is larger than "Alarm Threshold", the DVR will trigger a G-Sensor alarm.
- Alarm OSD: Set the title displayed and recorded in the screen when there is a G-Sensor alarm.

- Alarm Record: Set up the G-Sensor alarm recording.

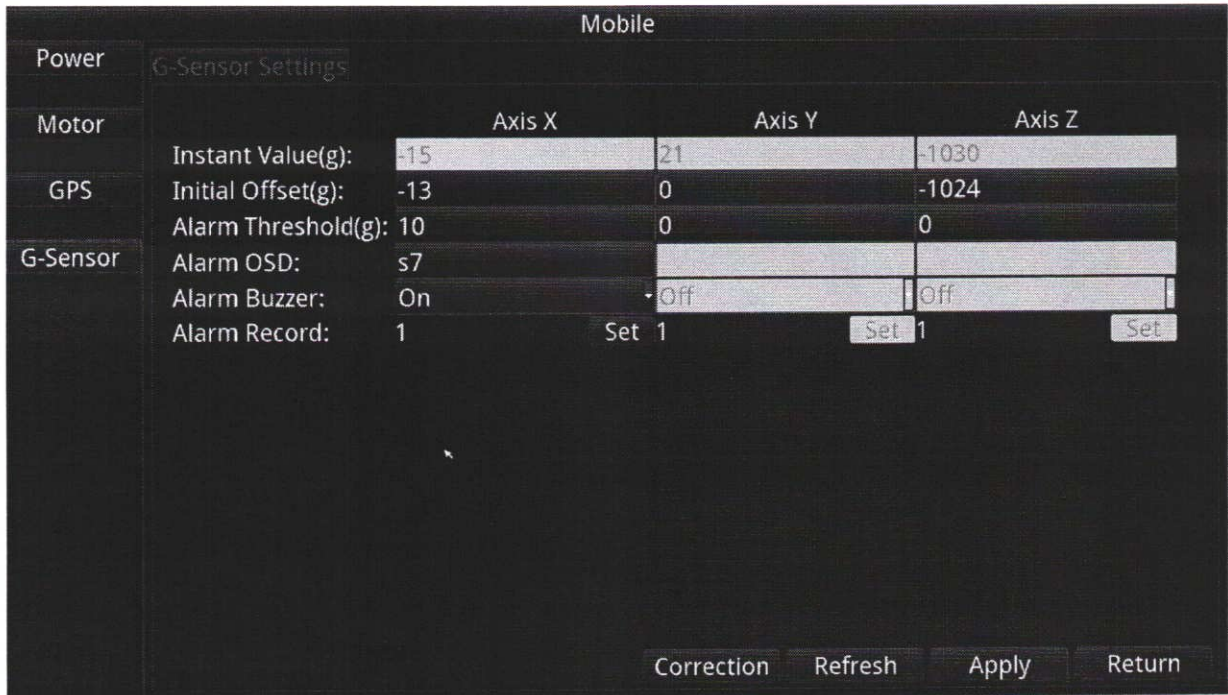

### 3.16 3G/4G Setting

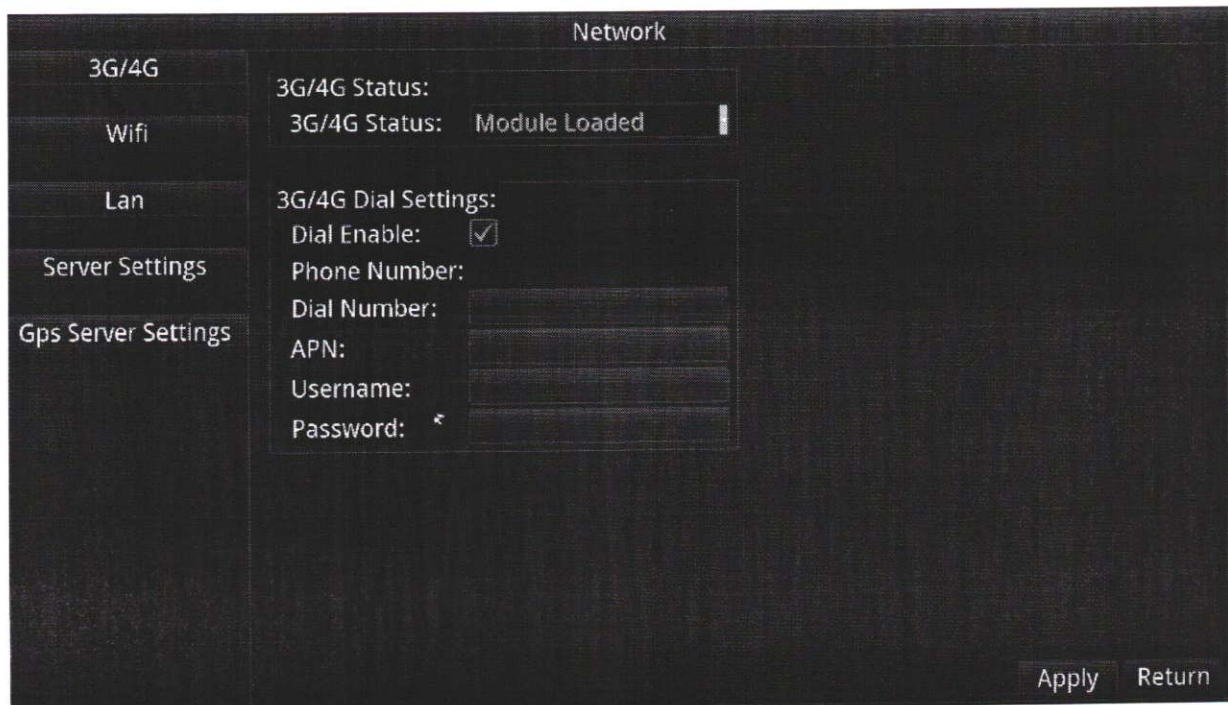

- 3G/4G Status:
  - Module Not found: The DVR did not find the built-in 4G/3G module.
  - Module Loaded: The DVR found built-in module, but can't connect to mobile network. It could be that no SIM card or 4G/3G signal is not good.
  - Mobile Connected: 4G/3G is working correctly.
- 3G/4G Dial Settings: User should set these parameters according to the parameters provided by

the mobile service provider.

- DVR can connect to an APN network, user need to enter APN parameters to access the APN network.
- The SIM card can't be hot swappable. If you change the SIM card, you should restart the DVR to make it take effect.

### 3.17 WIFI Setting

- Wifi Status:  
Connected: DVR connect to a wifi and access to internet successfully.  
Module Not Fund: DVR has not found built in wifi module.  
Module Loaded: DVR has detected wifi module but not found any wifi signal.  
Disconnected: No any wifi connection.  
Not Connect Internet: DVR has connected a wifi but can NOT access to internet.
- The wifi connected before can be saved in Wifi list, DVR can save up to 50 wifi SSID, and those wifi saved in DVR can be deleted.
- DVR support Access Point, the default password is 12345678.

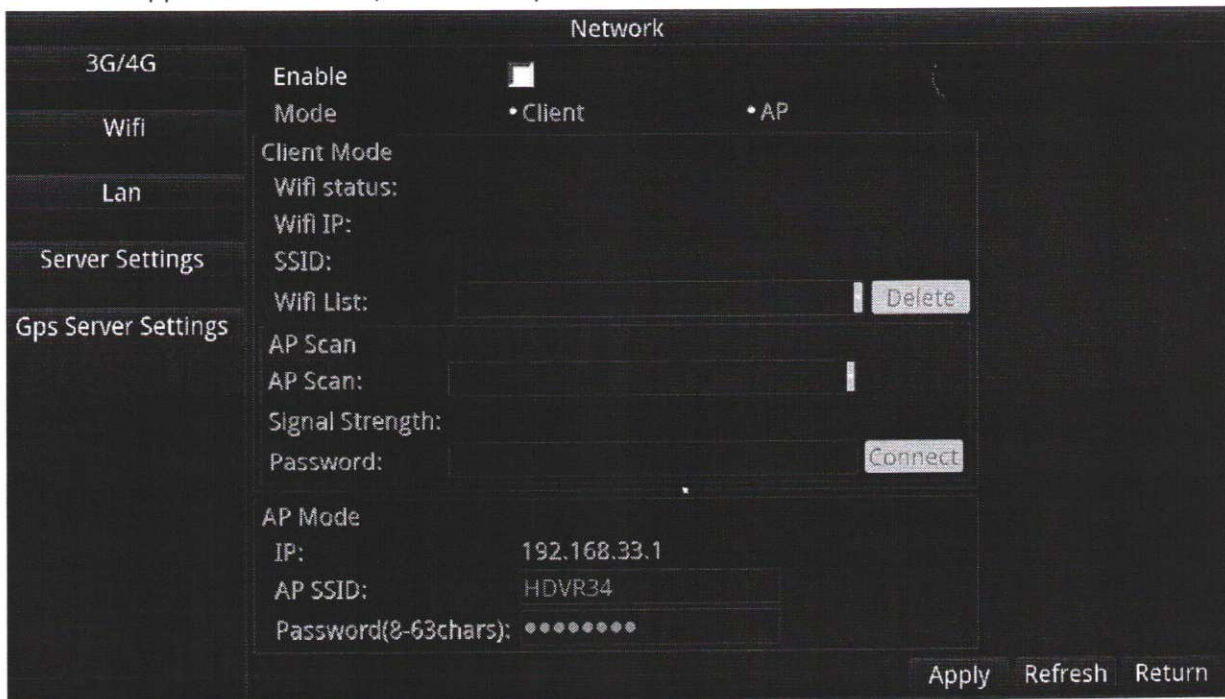

### 3.18 Network Setting

- DVR support dynamic IP and static IP.
- The network setting should comply with the network setting where DVR is located.

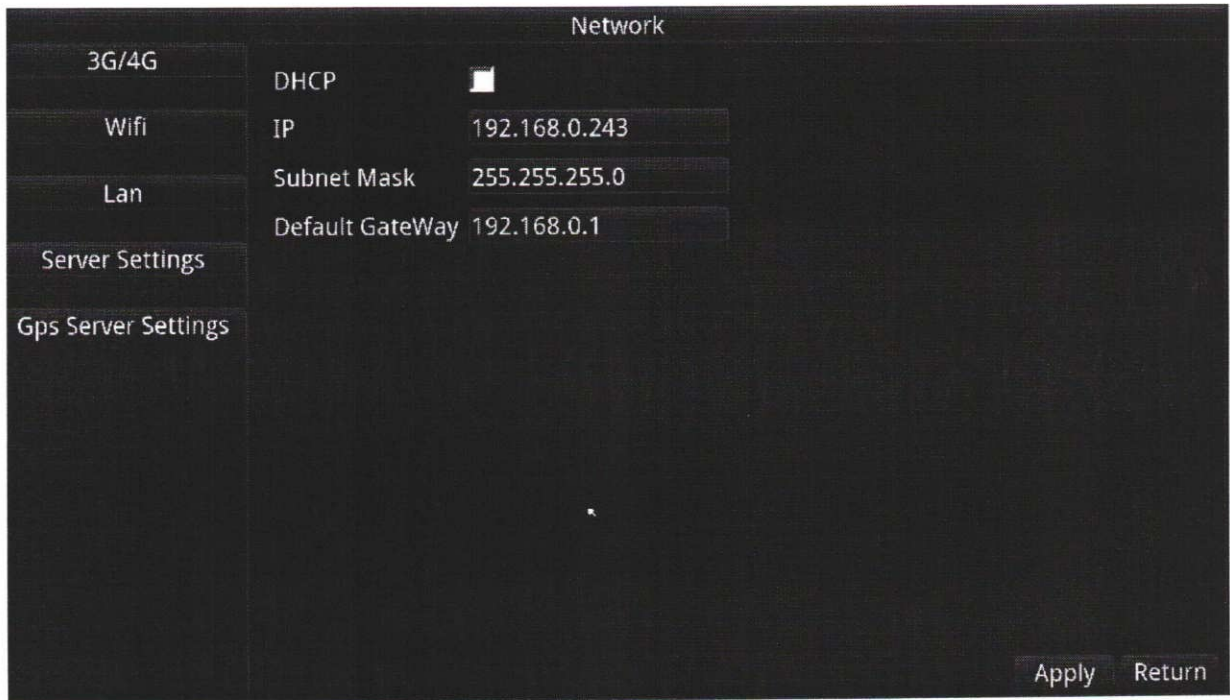

### 3.19 Server Setting

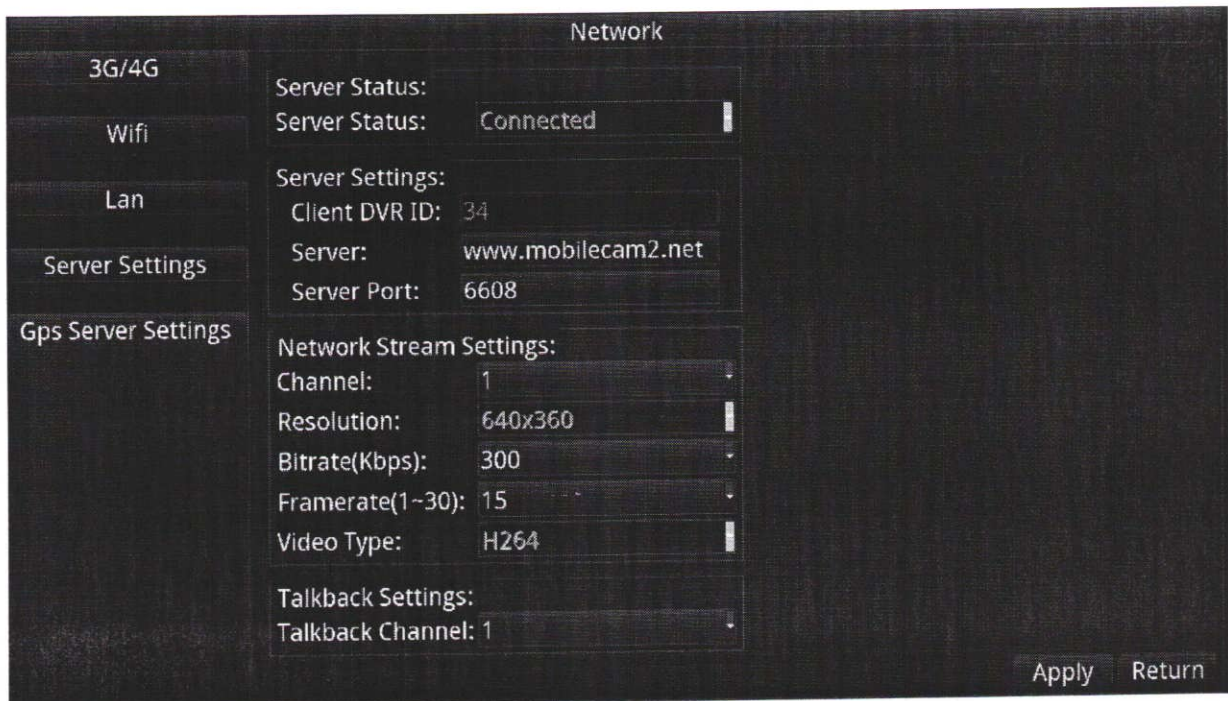

- Server Status:  
"Connected" means DVR is connected with server correctly. "Disconnected" means DVR is not connected with server.
- DVR ID is the ID for server, user can't change this value.
- Server IP is the IP of the server, usually no need to change.
- Server port is the port for communication. The default port number is 6608. Usually no need to change this value.



- The video type can be set to H264 or H265 (according to the camera model). Theoretically, under the same picture quality, H265 costs 50% bandwidth comparing with H264.
- Network Stream Setting: these are parameters for live streaming via 4G/3G. The default resolution is 640x360, bitrate is from 10Kbps and 1500Kbps. Frame rate is from 1fps to 30fps.
- DVR can connect intercom to communicate with platform.
- The GPS Server settings can be use for sending GPS data to USER's server.

### 3.20 System Setting

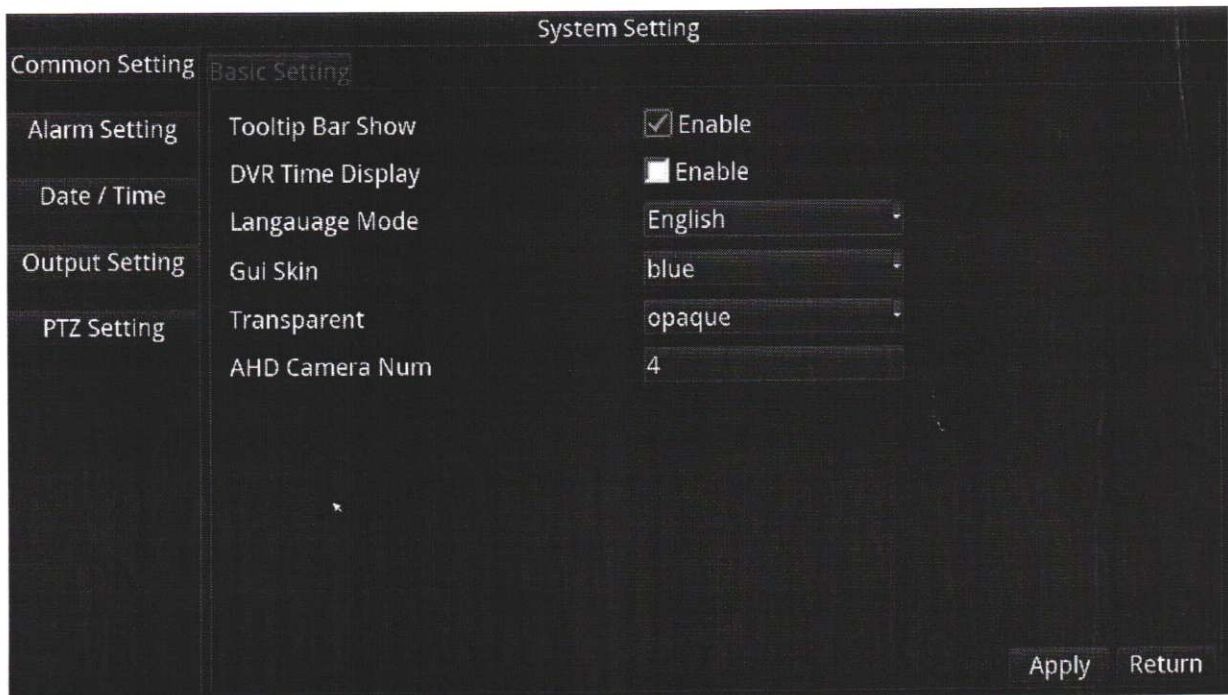

- Enable the "Tooltip Bar Show" and "DVR Time Display", the bottom of preview interface can show the storage ,network information and DVR's time.
- DVR support multiple language.
- Can set the number of digital cameras and analog cameras.

### 3.21 Alarm Setting

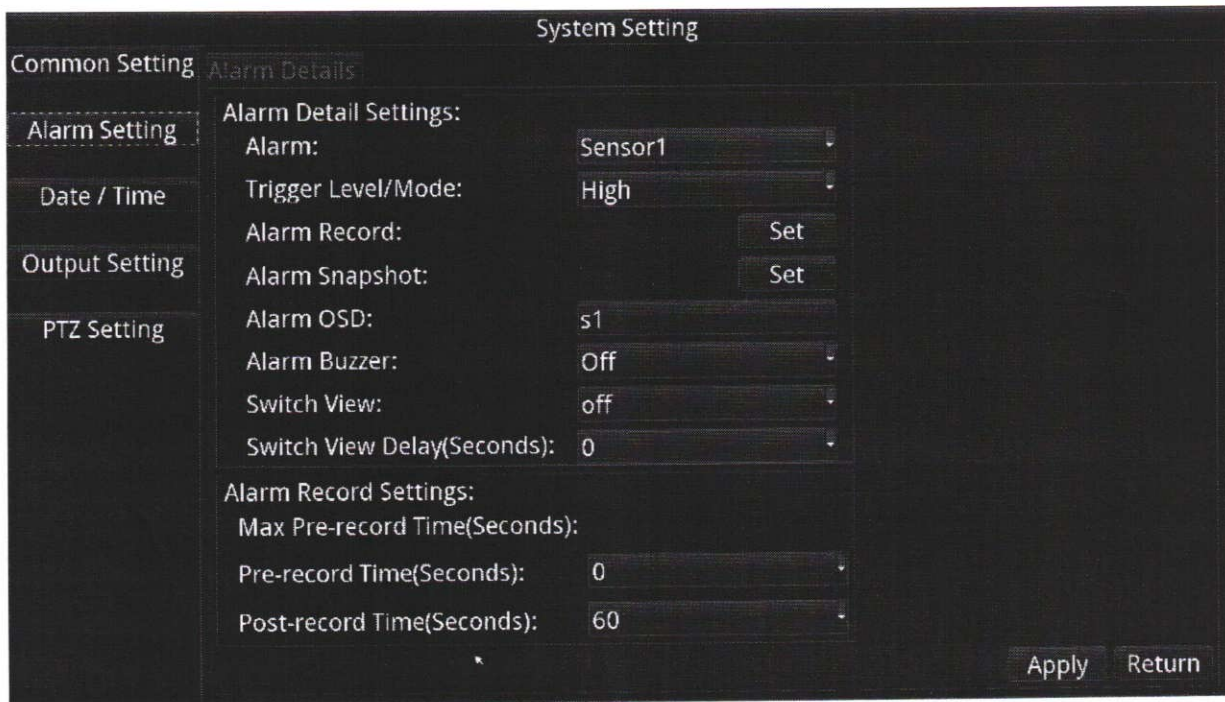

- DVR have 3 alarm sensors. In alarm setting you can setup these 3 sensors.
- Trigger Level: If the trigger level is set to high, a high level voltage on the sensor will trigger an alarm. You can check the "Trouble Shooting" at the end of this manual for the definition on the high level and low level.
- User can set up the alarm recording for these events.
- Alarm OSD: the title user want to display on the screen and be recorded with video.
- Alarm Buzzer: Enable/Disable buzzer when there is alarm.
- Switch View: Choose one camera to be in full screen mode when there is alarm. This can be used for rear view full screen or side view full screen. For example, user can connect sensor 1 to return signal, and if camera 1 is the rear view camera, we can set the "switch view" for sensor 1 to 1. In this way, when the vehicle is returning, camera 1 will be displayed as full screen on the monitor.
- Switch View Delay: The DVR will keep switching the camera until the alarm is not triggered for specified delay time. This is useful for side view camera. For example, if the left side camera is camera 2, and user connect sensor 2 to the left light signal on the vehicle. When the driver is switching to left light, the sensor 2 alarm will be triggered. But usually the left light will not be always on, it will be blinking like on, off, on, off... So the sensor 2 alarm will also be on, off, on, off... In this case, we can set "Switch View Delay" for 5 seconds, e.g., for sensor 2 and set "Switch view" for sensor 2 to camera2, then the DVR will keep camera 2 in full screen mode, until the sensor 2 alarm is off for over 5 seconds.
- Pre-Record Time: The time DVR will keep for recording before the alarm is triggered.
- Post-Record Time: The time DVR will keep for recording after the alarm is triggered.
- All of the alarm record files will be kept in a separate alarm folder, the files in the folder will not be overwritten.

## 3.22 Set Date and Time

The screenshot shows the 'System Setting' window with a sidebar on the left containing menu items: 'Common Setting', 'Alarm Setting', 'Date / Time', 'Output Setting', and 'PTZ Setting'. The main area is titled 'DST Setting' and is divided into two sections. The first section, 'Date/Time Settings:', contains four rows: 'Date Format:' with a dropdown menu showing 'yyyy-mm-dd'; 'DVR Time:' with a text field containing '2019.02.27. 07:27:54'; 'Set Time:' with a text field containing '2019.02.27. 07:27:52'; and 'Time Zone' with a dropdown menu showing '(GMT) Greenwich Mean Time : Dublin,Lisbon, London,Casa'. The second section, 'Dst Settings:', contains four rows: 'DST Period' with a dropdown menu showing 'No'; 'DST Setting' with a dropdown menu showing 'Disable'; 'From' with a dropdown menu showing 'Last Week', a dropdown menu showing 'Sun.', and a spinner control showing '0' and 'hour'; and 'To' with a dropdown menu showing 'Last Week', a dropdown menu showing 'Sun.', and a spinner control showing '0' and 'hour'. At the bottom right of the main area are two buttons: 'Apply' and 'Return'.

- User can choose different date format.
- DVR time is only used for displaying current time. It's not editable here.
- You can set the DVR time in "Set Time". If you find the DVR time is not changed as you specified, please check to see if you have enabled the "Sync With GPS Time".
- User can choose different time zone.
- Time Offset usually used in some country that is using special time zone, like India.
- DST now support USA/Australia/New Zealand/UK.
- User can set up the rules for DST in their own country if the country is not listed above.

## 3.23 Output Setting

- The DVR can connect HDMI and CVBS monitor at the same time, and the audio output is based on the setting of the "output device".
- The DVR supports the volume adjustment for CVBS monitor and the time for DVR to enter Screen Saver mode can be set. When it is set to "0", DVR would NOT enter Screen Saver mode.
- CVBS Output Reduction Value means that the user can adjust the output display pixel according to the current CVBS screen.

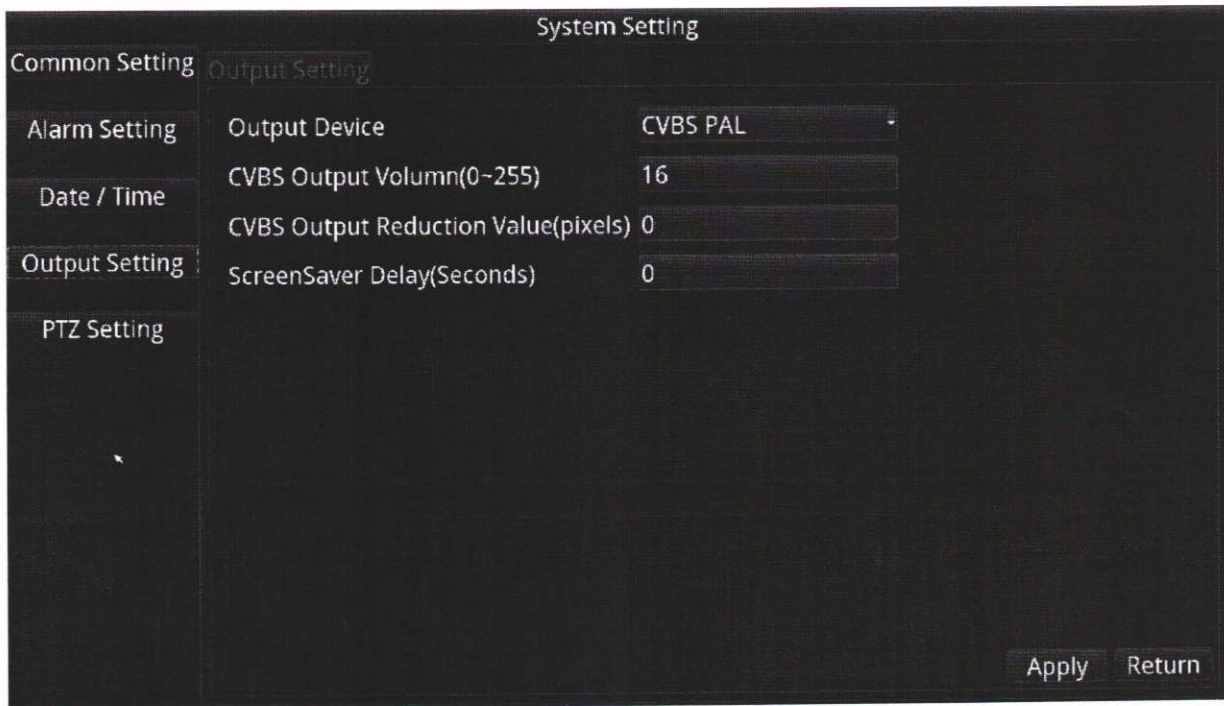

### 3.24 Record Play back



- User can play back the files on SD.
- The record files are listed according time and cameras.
- When playing back, user can fast forward, slow forward, pauses, step for playing.

### 3.25 System Information

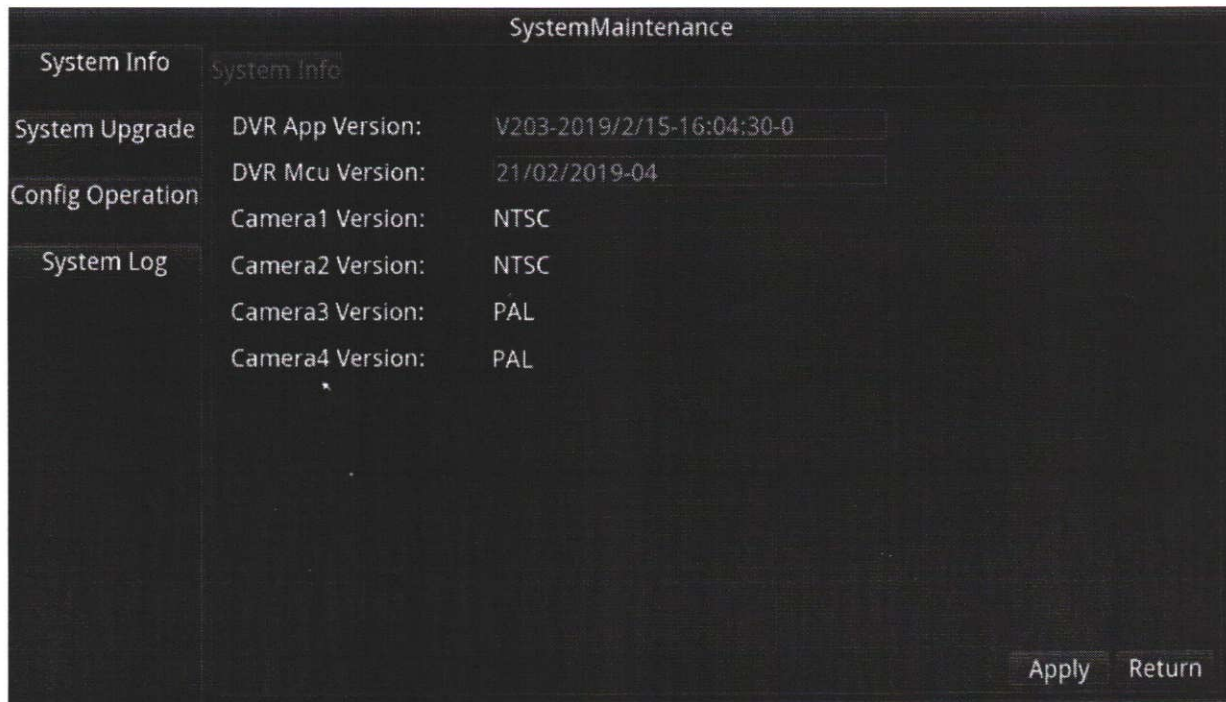

- In system information, it will display the firmware version, MCU firmware version, camera firmware version.

### 3.26 System Upgrade and Log

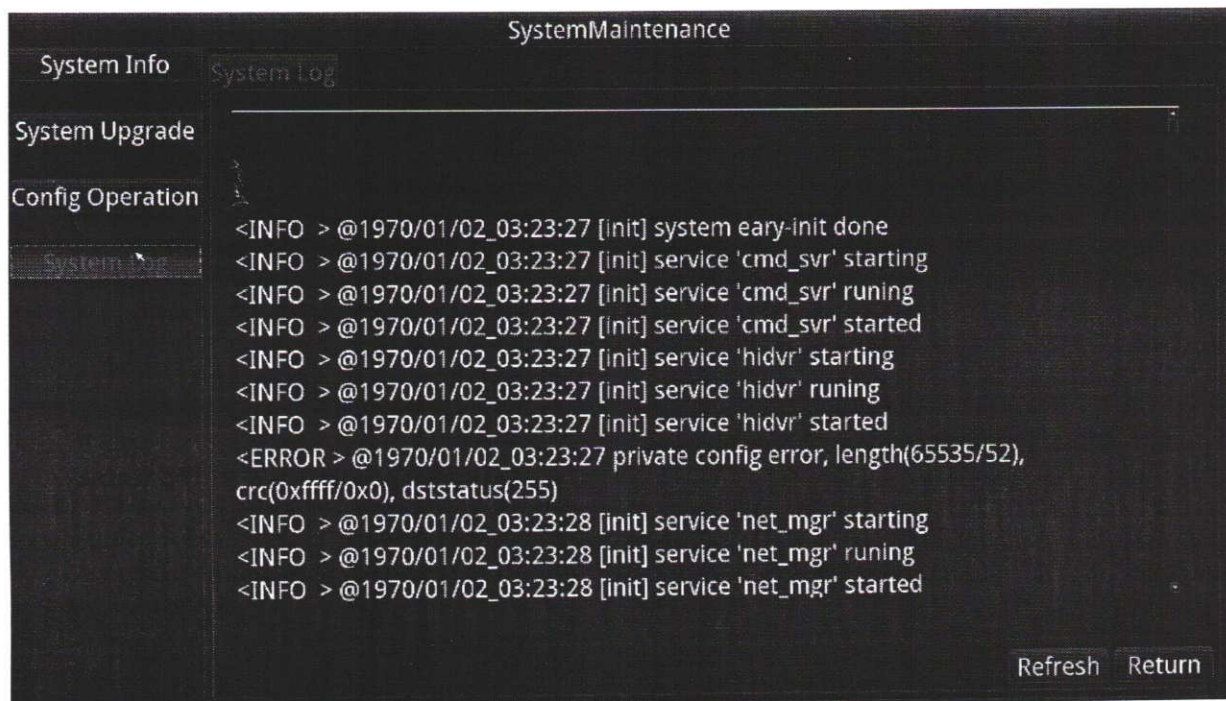

- The firmware upgrade file is a file with "tar" as file extension. Other files can't be used for upgrade.

- When upgrade is finished, DVR need to be restarted before new firmware take effect.
- The DVR can reset to default setting. Please note, all setting will be lost if DVR is reset to default setting. The DVR will need to be restarted to make the default setting take effect.
- The DVR setting can be exported to a file. This file can be used to import to other DVR to have the same setting. Importing setting of DVR will need to restart the DVR to take effect.
- For DVR support 4G/3G, user can import the setting to DVR via 4G/3G.
- User can connect a SD card or USB drive to get the DVR's log.

## 4. Specification

Model		SDVR104
SYSTEM	OS	Linux 3.18.20
	Booting Time	<20 s (From Powered on to start recording)
	Language	Chinese/English/Russian
	UI	GUI
	Power	Power In: 8V ~ 32V DC, Power out for analog camera: 12V/1.5A (4 cameras)
Video	Video Input	Maximum for 4x Analog cameras(PAL or NTSC...)
	Video Output	1 Video Output (1 CVBS output)
	Preview	Support FullScreen/Dual View/Quad View
	Record Mode	Auto Record, Schedule Record, Alarm Record
	Record File	Record video and audio at same time
	Compression	H.264 /H.265
	Frame Rate	100fps@720x576(PAL); 120fps@720x480(NTSC); or others
Audio	Audio Input	4 audio input (audio is built in the camera)
	Audio Compression	PCM
Video Process	Record Resolution	Support 720x576(PAL) or 720x480(NTSC), depends on the type of camera
	Bitrate	100~8000 kbps for each camera
	Storage	SD card up to 256GB, the video file format is AVI
Alarm	Alarm Input	3 alarm sensors input, 1 speed input, 1 ignition input, 1 panic button alarm, 1 G-Sensor alarm
	Alarm Output	1 beeper, Alarm OSD
	Event	Video Loss Event, Over Speed Event, G-Sensor Event, Storage Event, Motion Detection Event, Panic button Event
Communication	RS485	One RS485 port
	RS232	One RS232 port (For GPS)
	RJ45	One RJ45 port, 100M network
	USB	One USB, can be used for mouse, USB stick
Network	Protocol	TCP / IP
	3G/4G	Optional, build in 3G/4G(HSUPA/HSDPA/WCDMA/EVDO/TD-SCDMA/FDD-LTE/TDD-LTE)
	WIFI	Optional, support WIFI connection and AP
Location	Location	Location feature is optional, Support GPS/GLONASS/BEIDOU, recording location, speed, live tracking
Firmware	Frame Rate	Recording frame rate: 1~30fps selectable for each camera
	License ID	Support
	Camera Name	Support

	OSD	Display and record time, license ID, camera name, location, speed
	Firmware Upgrade	Can use USB disk/SD card/remote upgrade via 4G
	G-Sensor	Support
	Play back	Support play back, file listed by time, alarm
	Play Speed	Support from 1/32 to 32
Software	hPlayer	Player software, play multiple cameras together, can also play the encrypted file
	CMSV6	Used for 4G/3G model only, support live view/live tracking/historical track/remote upgrade
Power Input	Power Input	8VDC~32VDC
Power Output	Power Output	Power output for cameras: 10.5V/1.5A (4 cameras)
ACC	<4.5V	Ignition Off
	>6.2V	Ignition ON
Power Control	Ignition	Turn on the DVR when ignition is on, can set DVR to turn off after a specified time when ignition is off
	Power Consumption	Less 5.0W (No camera power consumption included)
Other	Size	118x92x20 mm
	Weight	About 0.2kgs
	Time	Internal clock, can synchronize with GPS
	Dual bit stream	Two different bit stream for recording and live streaming via 4G/3G
	Power Protection	Protect power from short cut, over load and error connection
	Default	Can set to default setting
	Light Indicator	Light Indicator for power, run, alarm network, 4G/3G
	Over Write	Support
Working Condition	Time Synchronize	Synchronize with GPS
	Working Temperature	-25 ~ 55°C
	Working Humidity	5%~93%



## 5. Trouble Shooting

### **1. Q : After connecting the DVR power, no videooutput, the first and second indicators lights on panel flashing alternately.**

A: The No.1 and No.2 indicator light is "Power" and "Run". If the 2 indicators lights are flashing alternatively, the DVR missed the ignition signal, please check if the yellow line of the input power lines has connected with the power positive level, or if it's the same as the setting of the effective electrical level in menu settings. (The factory default settings set the high level effective, that is, it is effective when the yellow ignition signal line is connecting with the power positive level .)

### **2. Q: As SD's capacity limited, how to make the videos' time expand to meet the requirements of the customers?**

A: Reduce the video frame rate, video resolution.

### **3. Q: when using the SD card, ScreenTip appears "read only error ".**

A: Please check if the SD card is write-protected, if so, please move the picks to the non - write protected.

### **4. Q: What is a high level, what is low level?**

A: Generally, there are two electrical levels in the car, the power and the ground. Automotive power voltage with 12V and 24V, we generally call it high level, not the specific voltage value. Ground of Vehicle is the reference level, accurately is battery negative electrode. We generally call it low level. For cars with negative switch control (the main switch cut off the connection of the battery cathode and car chassis ground), the chassis ground connects to the battery anode through a certain resistance, the chassis ground is not a reference ground anymore. Please see the Appendix in the back, including the potential analysis diagram against cars with negative switch control.

### **5. Q: Respectively, what's the voltage reference range of the high and low level in the DVR?**

A: The voltage range of low level is DC 0V~1.5V, the high level is DC 2.8V~32V.

### **6. Q: Why doesn't the DVR remote control work?**

A: Please make sure the battery in the remote control is still good, or try to change a new battery. And make sure aiming the remote control at infrared receptor window on the front panel of DVR.

### **7. Q: SD cards or hard disc are OK, but the video recording doesn't work, what should I do?**

A: Please make sure if the default setting of Record Mode is changed from "Automatic" to " Off ", and whether to modify the DVR to scheduled record mode and the current time is not within the time period you set.

**8. Q: Do your Mobile SD DVR support the capacity of 64G and above SDXC card?**

A: Yes, The SD DVR support the capacities of 64G and above SDXC cards.

**9. Q: when the disk is inserted the DVR for recording, live images or playback visual will come to a frequent halt.**

A: Please make sure that if your SD card's writing speed is enough. When the recording medium's writing speed is not enough, it will affect the continuity of live video and the real-time recorded video.

**10. Q: Do internal real time clock of the DVR maintained by batteries? If so, how long will it last?**

A: Rechargeable batteries are used for DVR internal real time clock. If the battery is fully charged and DVR is completely disconnected from the power supply, internal real time clock can probably last for 1 month.

**11. Q: what do the 5 indicator lights representative on the panel of the DVR?**

A: Please check 2.1 front panel in this manual for the use of these light indicator.

**12. Q: what kind of player software should use to play back video slots in SD on the PC? Why some of them don't play normally?**

A: The Mobile DVR recording files is a standard AVI format, video stream compression standard is senior H. 264.

1. Mobile DVR has its own player software, the hPlayer, including many special additional feature, such as playing continuously, fast forward playing, and other quickly locating recording and playing.

2. The recorded files also support general players. Such as VLC (version 1.0.0 and above, free open source software, can download from the internet), Media Player Classic(version 2009 Build: 3.9. above). Older Storm Audio can only support for video of 720x576 - resolution, when playing high resolution (1280x1024) recorded video file of Composite Mode, it can't display all the images, images on the right and below the video will be cut-off.

3. For file with encryption, you will need to use hPlayer to play it.

**13. Q: How to upgrade the Mobile DVR program?**

A: 1.Copy the update package (Suffix ".tar" files) to the root directory of SD (USB disk). Be careful not to extract.

2. Insert the disk to DVR, after the machine detects the SD, use the menu system in the DVR to choose "system upgrade" to upgrade the firmware.

**14. Q: Does your DVR have RS485 control PTZ functions?**

A: For very few of car application using PTZ control, mobile DVR factory default is without the RS485 control PTZ functions. If you do need PTZ control function, please contact sales when ordering.

**15. Q: I bought the mobile DVR with PTZ control function, but it has no response after PTZ connecting.**

A: After you have confirmed your machine already has PTZ control function, you may test your control functions in accordance with the following:

- 1, Exchange the two lines of 485A and 485B, to see if they are connected wrong;
- 2, Confirm if the PTZ Protocol is right;
- 3, Confirm if the PTZ Address is right, our default is 1, trying to adjust to 0 or 2; generally the PTZ address code is 1. The address code needs to be changed when multiple PTZ devices connected. In addition, the address of each PTZ device cannot be duplicated, if you have 4 PTZ devices, you can respectively set them to address 1, address 2, address3 and address 4.

**16. Q: How long will my SD of 256GB record?**

A: when you are setting record details in the DVR, you can see the estimated disk usage for each camera, you can calculate the time for recording according to these data.

**17. Q: what is "Power OFF Delay"?**

A: Users who need to install DVR often want the DVR to record the images inside and outside the car for a while after the driver turn the engine off. That is, DVR cannot be turned off after engine is shutdown, it should be off after record continuously for the specified period of time. This time is called "Power OFF Delay" time, such as 30 seconds. You can set the time you need on " Power Off Delay ".

When the users who need "Power OFF Delay" function, the positive level of the DVR and the ground should be connected directly (through the fuse) to the cathode and anode of the car battery, at the same time attach car ignition signal line to the ACC of the car.

Of course, the time of "Power OFF Delay" cannot be set too long, because after the engine shutdown, mobile DVR entirely depend on the power of the car battery to work, we should prevent the vehicle can't start correctly next time if the mobile DVR drained the energy of the car battery.

**17. Q: Click the screen audio icon to open the audio real-time output, but the monitor no sound output.**

A:Make sure that the the monitor supports audio output. If the support screen supports audio output, check whether the type of monitor matches the settings. (Should correspond to the settings under "System Setting" → "Common Settings" → "Output Device")

## 6. Packing List

Standard Packing List:

<b>Item</b>	<b>Description</b>	<b>Quantity</b>
1	DVR	1 set
2	DVR enclosure	1 set
3	DVR enclosure key	2 sets
4	AV input cable	2 pcs (can choose BNC connectors or 4-pin connectors)
5	Power cable	1 pc
6	AV output cable	1 set
7	Fuse holder	1 set
8	5A fuse	2 sets
9	Composite cable	1 set
10	Manual	1 set
11	3G/4G antenna	1 set (only applicable for 4G/3G model)
12	Screws	6 pcs

Optional accessories(need to buy separately):

<b>Item</b>	<b>Description</b>
1	GPS receiver
2	Control Panel
3	Camera extension cable (3 meter, 6.2 meter, 10 meter)